



Workshop Manual



2 STROKE ENGINE

MX - EN - SMX
SMR - 2019

250-300

Foreword

This publication, to be used by TM Racing workshops, has been drawn-up to assist authorised personnel in the maintenance and repair of motorcycles handled. Perfect knowledge of the technical data stated herein is decisive for the most complete professional training of the operator.

In order to make it easier to understand, the paragraphs have been distinguished by schematic illustrations, which highlight the topic in question.

Always operate in compliance with the accident-prevention regulations in force, using suitable PPE.

COOLANT LIQUID

DANGER

FIRE RISK: IN SOME CONDITIONS, THE COOLANT IS FLAMMABLE. ITS FLAMES ARE INVISIBLE, BUT CAN CAUSE BURNS. DO NOT POUR COOLANT ONTO EXHAUST SYSTEM COMPONENTS OR ONTO ENGINE COMPONENTS, SINCE THEY COULD BE HOT AND IGNITE THE COOLANT, WITH THE RISK OF BURNS. KEEP IN MIND THAT THE FLAMES ARE INVISIBLE. COOLANT MAY IRRITATE THE SKIN AND IS TOXIC IF SWALLOWED. KEEP COOLANT OUT OF THE REACH OF CHILDREN. COOLANT IS HIGHLY POLLUTANT. THEREFORE, AFTER USE, IT MUST BE DISPOSED OF AT SPECIAL COLLECTION CENTRES IN COMPLIANCE WITH THE REGULATIONS IN FORCE IN THE COUNTRY IN WHICH THE MOTORCYCLE IS USED.

USED ENGINE OIL AND GEARBOX OIL

DANGER

KEEP OUT OF THE REACH OF CHILDREN. ENGINE OIL AND GEARBOX OIL CAN SERIOUSLY DAMAGE SKIN IF HANDLED REGULARLY OVER LONG PERIODS OF TIME. WASH YOUR HANDS THOROUGHLY AFTER HANDLING THE OIL. WEAR LATEX GLOVES OR EQUIVALENT DURING MAINTENANCE WORK ON THE MOTORCYCLE. OIL IS HIGHLY POLLUTANT. THEREFORE, AFTER USE, IT MUST BE DISPOSED OF AT SPECIAL COLLECTION CENTRES IN COMPLIANCE WITH THE REGULATIONS IN FORCE IN THE COUNTRY IN WHICH THE MOTORCYCLE IS USED. DO NOT POUR USED OIL INTO DRAINS OR RIVERS. DISPOSE OF FILTERS AT SPECIAL COLLECTION CENTRES IN COMPLIANCE WITH REGULATIONS IN FORCE IN THE COUNTRY IN WHICH THE MOTORCYCLE IS USED.

Useful advice

In order to prevent problems on reaching an excellent final result, **TM Racing** srl recommends that the following generic regulations are complied with:

- in the event of any repair, assess the impressions of the Customer reporting the operating anomalies of the motorcycle and formulate appropriate questions in order to clarify the symptoms of the problem;
- clearly diagnose the cause of the anomaly. From this manual it is possible to assimilate the essential theoretical bases, which, moreover, must be integrated by personal experience;
- plan the repair rationally, in order to prevent downtimes, receiving spare parts, preparation of tools etc.;
- reach the item to repair, limiting to the essential operations.

In this regard, consulting the disassembly sequence shown in this manual, will be of great help.

General repair-related regulations

- 1 Always replace the gaskets, sealing rings and the cotter pins with new parts.
- 2 When loosening/tightening nuts or screws, always start with the largest ones or from the centre. Lock at the coupling torque prescribed following a crosswise pathway.
- 3 Always mark all parts or positions that could be exchanged on re-mounting.
- 4 Use original spare parts and recommended lubricants.
- 5 Use special tools, where specified.
- 6 Consult official Technical Memos, since they could contain more updated state adjustment data and methods of intervention, with respect to this manual.

TM Racing SPA, declines all liability for any errors in the compilation of this manual, and reserves the right to make any modifications required for the development of its products. Illustrations shown are approximate and, in some cases, may not precisely correspond with the part referred to. Reproduction of this publication, even partial, without written authorisation is prohibited.

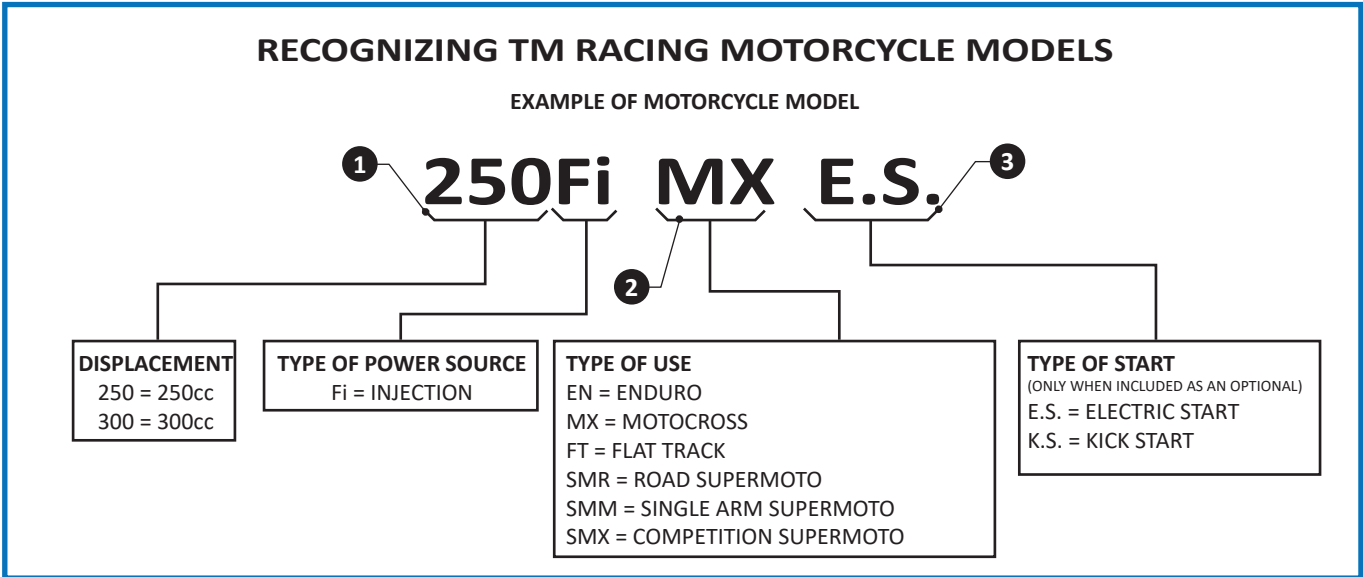

The displacement, type of power source and type of use define the motorcycle model and engine of each TM Racing motorcycle. The combination of codes 1 and 3 identifies the standard engine type. The combination of the three codes fully identifies the motorcycle model. All 3 codes are usually used in this Manual, to specify the motorcycle model to which certain information refers. If only codes 1 and 3 are indicated, followed by the word "ALL", it means that the information relates to all motorcycles with standard engine, regardless of the type of use. Code 2 (Type of Use) used alone means that the information refers to all motorcycles with that type of use, regardless of displacement and power source. All EN/SMR/SMM models are equipped as standard with electric start (E.S.) as well as kick start (K.S.). MX/SMX models have K.S. as standard and may be equipped with E.S. as an option.

Please make a note of your motorcycle's serial numbers in the boxes below. When it is necessary to contact TM for spare parts, updates or to report any issues, always quote the model, displacement, year of manufacture and, above all, the frame serial number and engine serial number.

ENGINE SERIAL NUMBER

The engine serial number (1) is embossed into the rear part of the engine, near to the shock absorber.

Make a note of this number in the relevant space at the beginning of the manual.

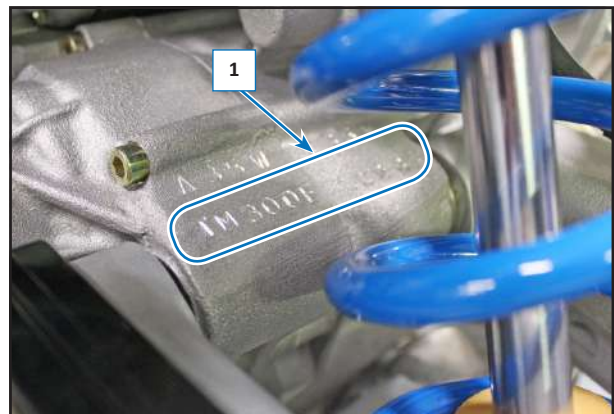

1.	ADJUSTMENTS/REPLACEMENTS	9
1.1	ENGINE OIL AND FILTER CHANGE	10
1.2	STANDARD CLUTCH REPLACEMENT	11
2.	ENGINE DISASSEMBLY.....	15
2.1	ENGINE COMPONENTS LAYOUT (MX-SMX)	16
2.2	ENGINE COMPONENTS LAYOUT (EN-SMR)	17
2.3	REMOVING THE PINION COVER.....	18
2.4	PINION REMOVAL	18
2.5	TEMPERATURE SENSOR REMOVAL	19
2.6	HEAD REMOVAL.....	19
2.7	INJECTORS DISASSEMBLY (EN-SMR)	20
2.7.1	Disassembly	20
2.7.2	Reassembly	21
2.8	CYLINDER AND PISTON	21
2.8.1	Cylinder and piston removal	21
2.8.2	Ring replacement and assembly	23
2.8.3	Strap mounting	24
2.8.4	Piston replacement	24
2.8.5	Piston replacement with intact cylinder	24
2.8.6	Piston replacement with cylinder to be machined	25
2.8.7	Cylinder replacement.....	25
2.8.8	Cylinder and piston re-mounting	25
2.9	CHECKING THE SQUISH.....	26
2.10	DRAIN VALVE REMOVAL / REVISION	28
2.10.1	Dismantling the lever (5).....	30
2.10.2	Refitting the lever (5)	31
2.10.3	Reassembly of the valve (13)	31
2.10.4	Valve height adjustment in closed position	33
2.11	REED VALVE PACK	34
2.12	CLUTCH	36
2.12.1	Clutch actuator removal	36
2.12.2	Actuator dismantling	36
2.13	Gear sensor.....	36
2.14	FLYWHEEL REMOVAL	37
2.14.1	Flywheel cover	37
2.14.2	Stator	38
2.14.3	Pick-up	38
2.14.4	Rotor	38
2.15	STARTER MOTOR.....	40
2.15.1	Disassembly	40
2.15.2	Re-mounting	40
2.16	WATER PUMP.....	42
2.16.1	Replacing the sealing gasket	42
2.16.2	Water pump removal.....	43
2.16.3	Reassembling the water pump	45

2.17	TRANSMISSION GUARD	46
2.17.1	Transmission cover re-assembly	47
2.18	IDLE KICK STARTER REMOVAL (ONLY K.S.)	48
2.18.1	Starter dismantling	48
2.18.2	Re-mounting	48
2.19	DRUM AND CLUTCH BELL	49
2.19.1	Disassembly	49
2.19.2	Re-mounting	50
2.20	TRANSMISSION SIDE COUNTER GEARS.....	52
2.20.1	Gears removal	52
2.20.2	Reassembly of gears	53
2.21	GEARBOX CONTROL SHAFT AND RATCHETS HOLDER REMOVAL	55
2.22	SEMICASE	59
2.22.1	Opening	59
2.22.2	Re-assembly.....	60
2.23	CRANKSHAFT, GEARBOX, GEARS DRUM	62
2.23.1	Components position.....	62
2.23.2	Crankshaft removal.....	62
2.23.3	Gear shafts removal.....	62
2.23.4	Primary shaft, gear sequence	63
2.23.5	Secondary shaft, gear sequence	64
2.23.6	Bearings replacement	64
2.23.7	Components re-mounting.....	65

ENGINE TECHNICAL DATA 250-300 MX SMX

ENGINE	250	300
Type	Single cylinder 2-stroke, liquid-cooled	
Displacement	249,3 cm ³	293,1 cm ³
Bore/stroke	66.4x72	72x72
Compression	14.5:1	11.5:1
Fuel	(E5) / (E10) super unleaded fuel mixed with oil at 3%	
Squish height	1.6 / 1.7 mm	
Piston height from the cylinder surface to the PMS	0.75 ÷ 0.80 mm	
Piston cylinder tolerance	0,06 / 0,07	
Engine shaft supports	2 roller bearings	
Small-end bearing	silvery needle roller cage	
Big-end bearing	needle roller cage	
Piston	forged in light alloy	
Segments	2 segments (GAP 0,60 / 0,65)	
Gearbox oil quantity	700 cc	
Primary transmission	straight-toothed gears 19/57	
Clutch	multiple disc oil bath	
Gearbox (with front couplings)	5 gears	
Gear ratios	1 ^a 15:27	
	2 ^a 17:25	
	3 ^a 19:23	
	4 ^a 21:21	
	5 ^a 23:20	
Ignition	CDI EMOTICOM	
Generator	12V 180W	
Regulator	KOKUSAN	
Spark plug	NGK BKR 8EIX	
Electrodes distance	0,7-0,75 mm	
Cooling	fluid, 40% antifreeze, 60% water (up to -25°C), circulation forced with pump	
Fluid amount	1 liter (see page 4-97)	

ENGINE TECHNICAL DATA 250-300 EN-SMR

ENGINE	250 EN	250 SMR	300 EN	300 SMR
Type	Single cylinder 2-stroke, liquid-cooled			
Displacement	249,3 cm ³		293,1 cm ³	
Bore/stroke	66.4x72 mm		72x72 mm	
Compression	12.5:1		11.5:1	
Fuel	(E5) / (E10) super unleaded fuel			
Engine lubrication	separated with Mikuni pump driven by engine ECU			
Squish height	1.6 ÷ 1.7 mm			
Piston height from the cylinder surface to the PMS	0.75 ÷ 0.80 mm			
Piston cylinder tolerance	0,08 / 0,09			
Engine shaft supports	2 roller bearings			
Small-end bearing	silvery needle roller cage			
Big-end bearing	needle roller cage			
Piston	forged in light alloy, graphitised shell			
Segments	2 segments (GAP 0,60 / 0,65)			
Gearbox oil quantity	700 cc			
Primary transmission	straight-toothed gears 19/57			
Clutch	multiple disc oil bath			
Gearbox (with front couplings)	5 gears			
Gear ratios	1ª 14:28 2ª 17:25 3ª 19:23 4ª 21:21 5ª 24:19			
Ignition	CDI EMOTICOM			
Generator	12V 180W			
Regulator	KOKUSAN			
Spark plug	NGK BKR 8EIX			
Electrodes distance	0,7-0,75 mm			
Cooling	fluid, 40% antifreeze, 60% water (up to -25°C), circulation forced with pump			
Fluid amount	1 liter (see page 4-97)			

CARBURETTORS SETTING MX-SMX

KEIHIN	250 MX	300 MX	300 SMX	300 MX BRASILE
Type	PWK 38	PWK 38	PWK 38	PWK 38
Needle	NOZE	N1EH	NIEG	NOZG
Needle position	4ª mark	3ª mark	3ª mark	4ª mark
Guillotine	6,5	6,5	6,5	6,5
Maximum jet	180	180	180	190
Idle jet	45	45	45	50
Air screw turns	1.5 turns	1,5	1,5	1,5
Float position	16 mm standard	16 mm standard	20 mm modified	16 mm standard

ENGINE TIGHTENING TORQUES

Carter Allen screw, transmission torque, clutch torque, ignition torque	M 6	12 Nm
Oil drain screw cap	M14x1.5	20 Nm
Oil load screw cap	M14x1.5	20 Nm
Valve adjustment grub screws	M 5	8 Nm
Valve adjustment locknuts	M 5	8 Nm
Laminated body Allen screw	M6	12 Nm
Cylinder-head tightening flange screw	M 8	27 Nm
Base-cylinder tightening flange nuts	M 10	35 Nm
Water pump cover Allen screw	M 6	12 Nm
Water pump rotor	M 6	Loctite 243 + 15 Nm
Clutch hub nut	M18x1.5	Loctite 243 + 80 Nm
Clutch springs Allen screw	M 6	10 Nm
Ignition stator Allen screw	M 6	Loctite 243 + 10 Nm
Limit switch plate fixing countersunk screw	M 6	10 Nm
Allen screw for gear blocker	M 6	Loctite 243 + 10 Nm
Ignition pedal screw	M 6	Loctite 243 + 25 Nm
Gearbox lever Allen screw	M 6	Loctite 243 + 10 Nm
Generic screws/nuts	M 5	8 Nm
Generic screws/nuts	M 6	10 Nm
Generic screws/nuts	M 8	25 Nm

LUBRICATION

Gearbox Oil	BARDAHL GEAR BOX - SAE 10-40
Automatic Mixer Oil	BARDAHL KTS COMPETITION or oil for automatic mixer
Oil for mix	BARDAHL KXT Synthetic SAE 50
Clutch Oil	DOT 4
Brakes Oil	DOT 4
Radiator liquid	BARDAHL PERMANENT SPECIAL FLUID

MAINTENANCE TABLE

	After 1 hour	Every 15 hours	Every 30 hours (after every ride)	Every 45 hours	Every 135 hours (75 hours of sports use)	Every year
Clean exhaust screw magnet		•	•			
Check tightness of engine fixing screws		•	•			
Replace spark plug and check cap					•	
Check exhaust valves				•		
Check cylinder and piston wear				•		
Fully change piston					•	
Check exhaust valve actuator play			•			
Exhaust valves replacement					•	
Fully change conrod					•	
Check clutch discs			•	•		
Check clutch springs				•		
Check transmission and gearbox					•	
Mixer oil pump replacement					•	
Fully change engine bearings					•	
Fully change engine oil seal					•	

⚠ WARNING

Change affected components if a defect is found or wear limits exceeded.
 The above operations must be performed by an authorized TM workshop or by specialized personnel.
 The hour meter is built into the dash.

Problem	Cause	Solution	
The engine does not start or struggles to start	Insufficient compression		
	1. Piston seizing	Replace	
	2. Rod head or foot seizing	Replace	
	3. Worn piston segments	Replace	
	4. Worn cylinder	Replace	
	5. Insufficient cylinder head tightening	Tighten	
	6. Insufficient head gasket sealing	Replace	
	7. Spark plug loosened	Tighten	
	Spark weak or non-existent		
	1. Faulty spark plug	Replace	
	2. Spark plug encrusted or wet	Clean or dry	
	3. Excessive distance between spark plug electrodes	Adjust	
	4. Apertures or short circuits in the high-voltage cables	Check	
	5. Faulty ECU	Replace	
The engine stops easily	1. Spark plug encrusted	Clean	
	2. Faulty ECU	Replace	
	3. Low idle speed	Adjust	
The engine is noisy	The noise seems to come from the piston		
	1. Excessive play between cylinder and piston	Replace	
	2. Segments or their housing in the piston worn	Replace	
	3. Excessive accumulation of carbon deposits in the combustion chamber or on the piston crown	Clean	
	The noise seems to come from the crankshaft		
	1. Bench bearings worn	Replace	
	2. Rod head radial or axial play high	Replace	
	3. Crankshaft gear damaged	Replace	
	4. Crankshaft fix. nut loosened	Tighten	
	The noise seems to come from the clutch		
	1. Discs worn	Replace	
	2. Excessive play between clutch bell and drive discs	Replace	
	The noise seems to come from the gearbox		
	1. Gears worn	Replace	
	2. Brake grooves consumed	Replace	
	The clutch slips	1. Weakened clutch springs	Replace
		2. Clutch discs worn	Replace
	The clutch opposes resistance	1. Spring load not even	Replace
2. Clutch discs bent		Replace	
The gears do not engage	1. Gearbox fork bent or seized	Replace	
	2. Gear ratchets worn	Replace	
	3. Forks command pins damaged	Replace	
	4. Gears locking ratchets springs broken	Replace	

Problem	Cause	Solution
The shift control pedal does not go back into position	1. Selector switch recall spring weakened or broken	Replace
	2. Gear forks worn	Replace
The gears disengage	1. Sliding gears couplings consumed	Replace
	2. Brake grooves worn	Replace
	3. Housings for couplings on the gears worn	Replace
	4. Grooves on the forks command shaft worn	Replace
	5. Forks command pins worn	Replace
Insufficient engine power	1. Air filter dirty	Clean
	2. Low fuel quality	Replace
	3. Intake coupling loosened	Tighten
	4. Excessive distance between spark plug electrodes	Adjust
	5. Insufficient compression	Check the cause
	6. Reed valve pack plates broken	Replace
The engine overheats	1. Combustion chamber and/or piston crown encrusted with carbon residues	Clean
	2. Obstructions to the air flow on the radiator	Clean
	3. Cylinder head gasket sealing faulty	Replace
	4. The clutch slips	Adjust

ELECTRIC PART

Problem	Cause	Solution
The spark plug electrodes overheat	1. Insufficient distance between electrodes	Adjust
	2. Heat rating too high	Replace with recommended spark plug
The starter motor does not start or slips	1. Faulty starter motor	Repair or replace
	2. Starter gears worn	Replace



1. ADJUSTMENTS/REPLACEMENTS

1.1 ENGINE OIL AND FILTER CHANGE

The oil must be changed with the engine off but still warm enough to allow the waste oil to flow out easily.

Position the motorcycle on a flat surface and prepare a suitable recipient under the same.

Loosen the introduction cap (1) positioned on the right side of the engine (clutch cover).

Collect the aluminum washer (2).

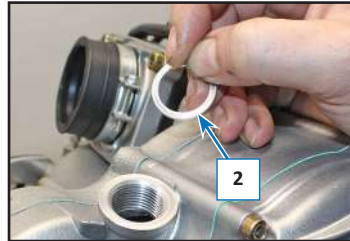
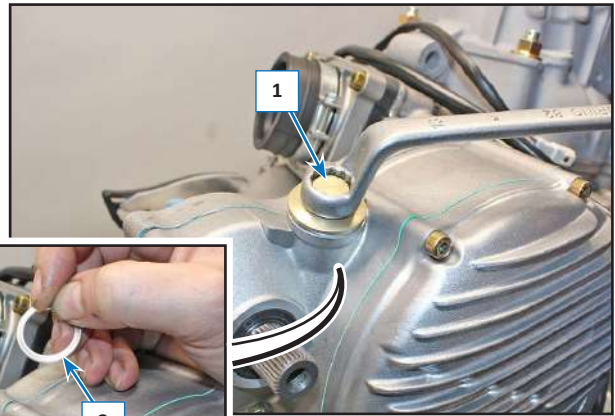

Unscrew the drain cap (3) located on the lower side of the engine and collect the aluminum washer (4).

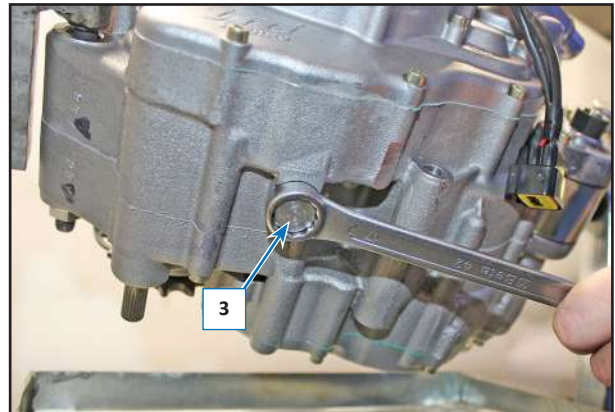

Wait for the oil to drain completely through the hole, clean the sealing surfaces, replace the aluminium washers (2 and 4), remove any magnetic debris (5) of the drain cap (3) and screw the cap back on, tightening to 20 Nm (2 kgm, 14,75 ft/lb).

Prepare a measure with the amount of the prescribed engine oil necessary (see table) and pour from the introduction hole.

Repeat the oil level check operation.

Check sealing of the filter cover introduction and drain caps.

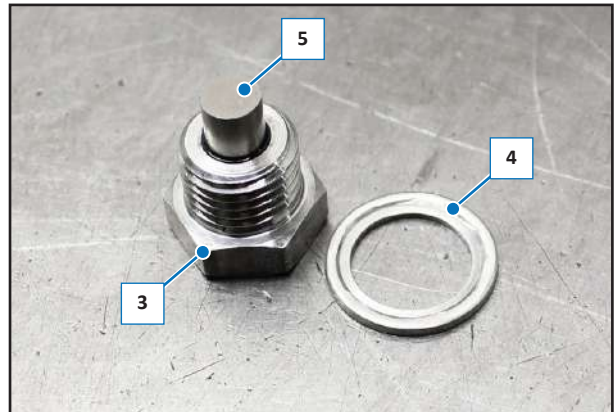

⚠ DANGER

- PAY ATTENTION TO THE HOT OIL AND PARTS OF THE ENGINE; THERE IS A BURNS HAZARD.

⚠ WARNING

- A level that is too low, poor quality oil or maintenance intervals longer than those prescribed, cause serious damage to the gearbox. Do not introduce an excessive amount of oil into the gearbox. If this should happen, drain it as described previously.

ENGINE OIL QUANTITY TABLE

Change oil.....650 gr.

1.2 STANDARD CLUTCH REPLACEMENT

Drain the engine oil as described in the relative paragraph. Unscrew the M5-L75 (1) and M5-L25 (2) screws, then remove the clutch cover (3).

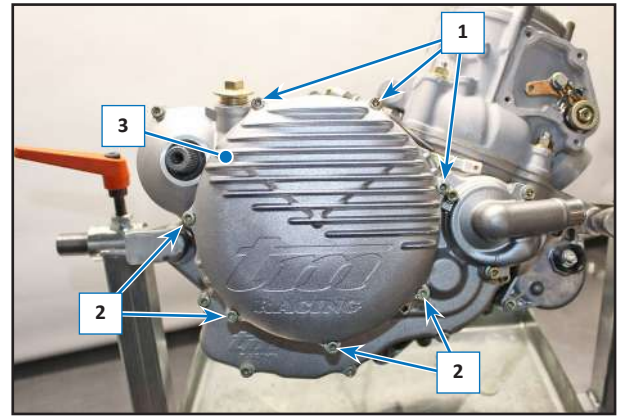

Remove the gasket (4).



Unscrew the screws (5) of the clutch pack.

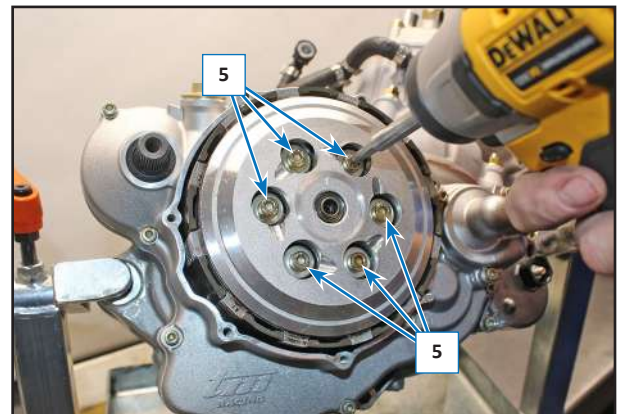

Remove the spring (6) and the pressure plate (7).

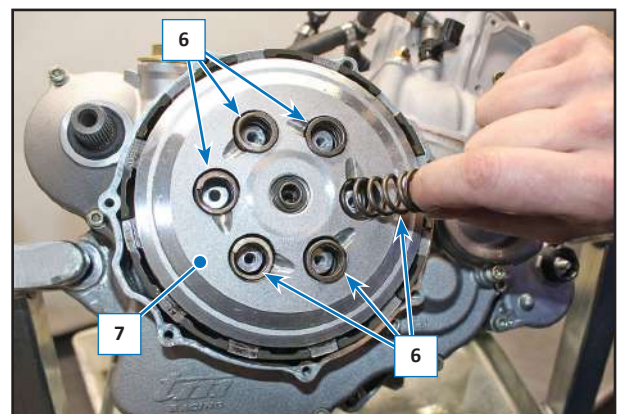

Check that the pressure plate (8) is present and remove it.

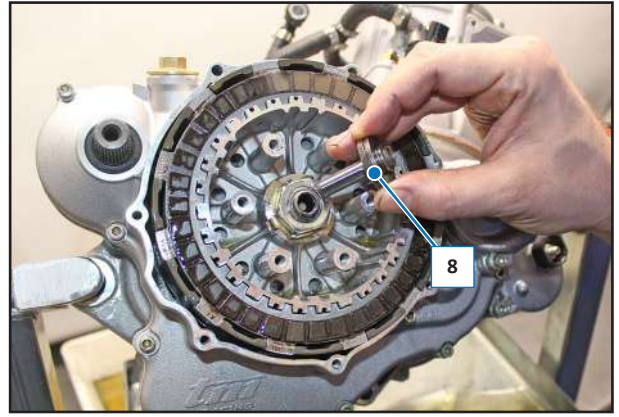

Use two sticks to pry up and remove the discs (9).

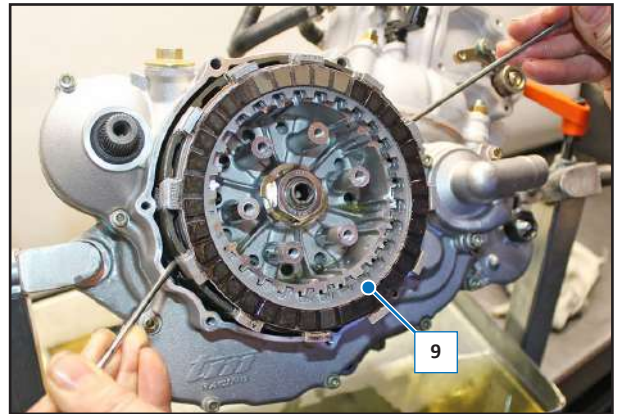

NOTE: On re-mounting the new discs (9), lubricate them with engine oil and make sure that the first disc mounted is lined.

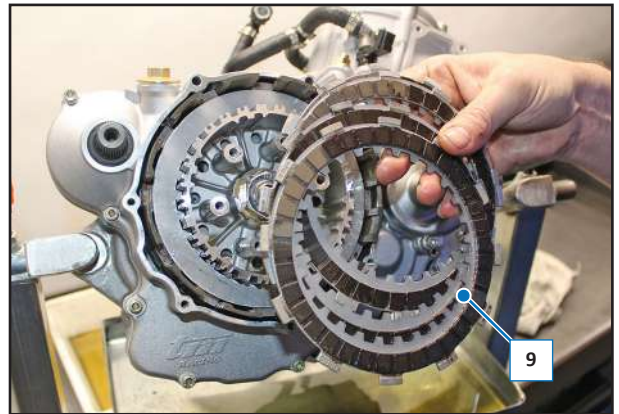

Remount the pressure plate (7) with the relative springs (6).

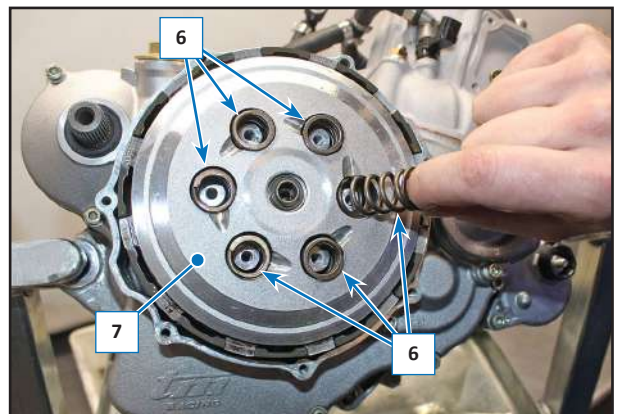

Re-mount the screws (5) and tighten them crosswise and gradually with a torque of 8 Nm (0.8 kgm/ 5.9 ft/lb).

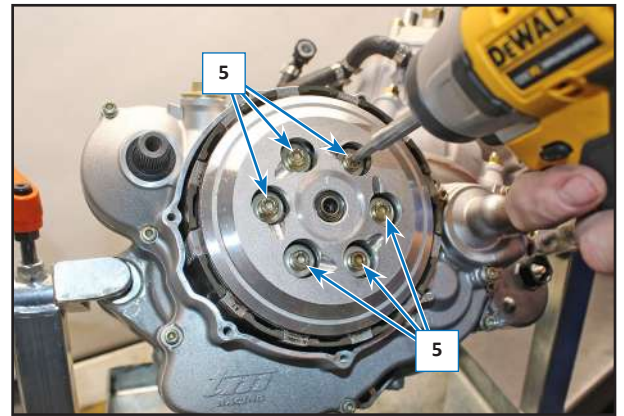

Check that the gasket (4) is not ruined, otherwise replace it, and mount it on the guard.



Mount the clutch guard (3) and tighten the screws (1) and (2) gradually with a torque of 8 Nm (0.8 kgm/ 5.9 ft/lb)

Introduce oil into the engine oil as described in the relative paragraph.

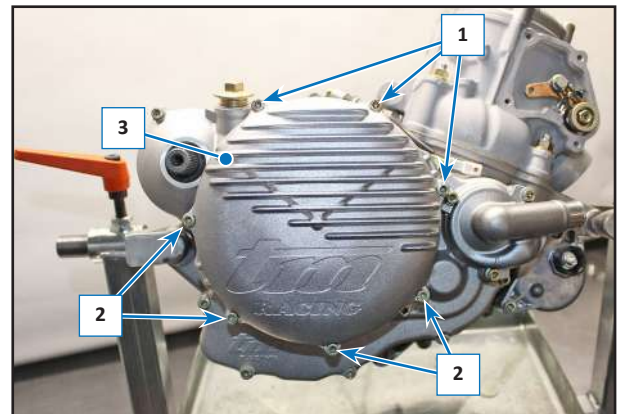





2. ENGINE DISASSEMBLY

2.1 ENGINE COMPONENTS LAYOUT (MX-SMX)

- 1 Cylinder head
- 2 Cylinder
- 3 Starter motor
- 4 Reed valve pack
- 5 Pinion
- 6 Transmission cover
- 7 Water pump
- 8 Ignition cover
- 9 Gear sensor
- 10 Clutch actuator
- 11 Drain valve

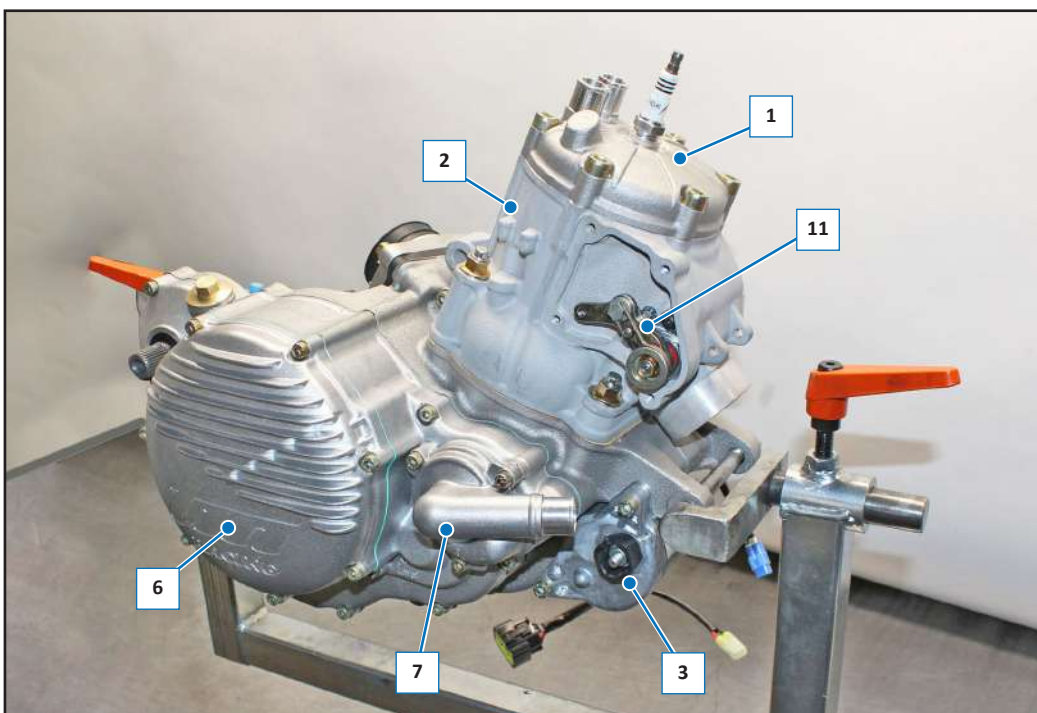
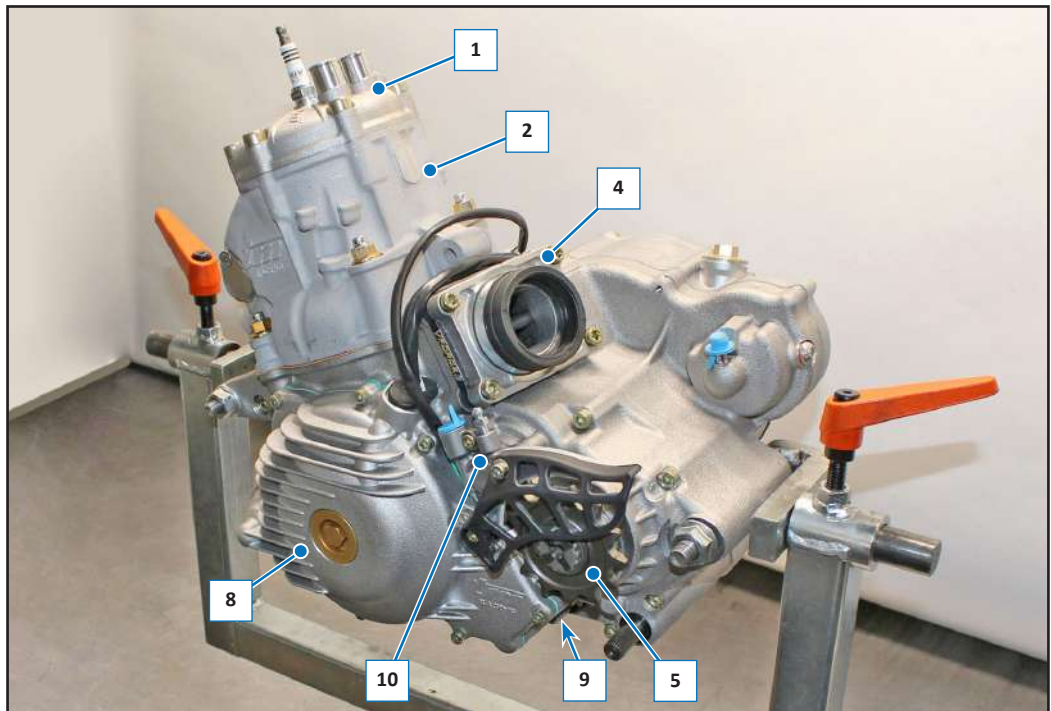

2.2 ENGINE COMPONENTS LAYOUT (EN-SMR)

- 1 Cylinder head
- 2 Cylinder
- 3 Starter motor
- 4 Reed valve pack
- 5 Water temperature sensor
- 6 Transmission cover
- 7 Injector
- 8 Water pump
- 9 Ignition cover
- 10 Gear sensor
- 11 Clutch actuator
- 12 Pinion
- 13 Drain valve

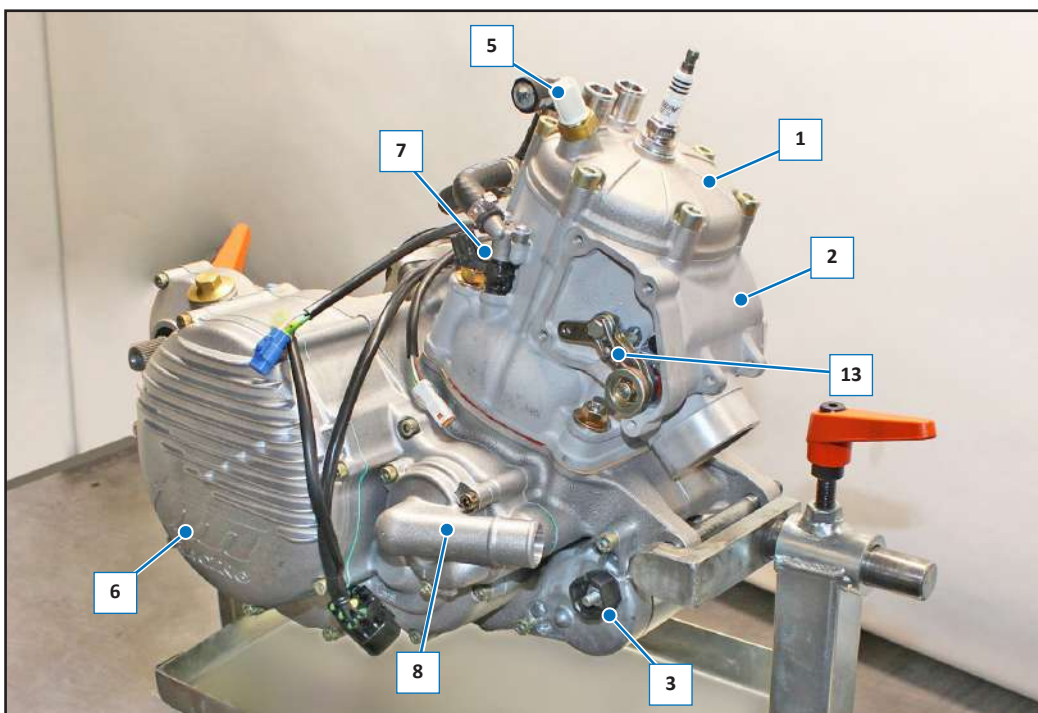
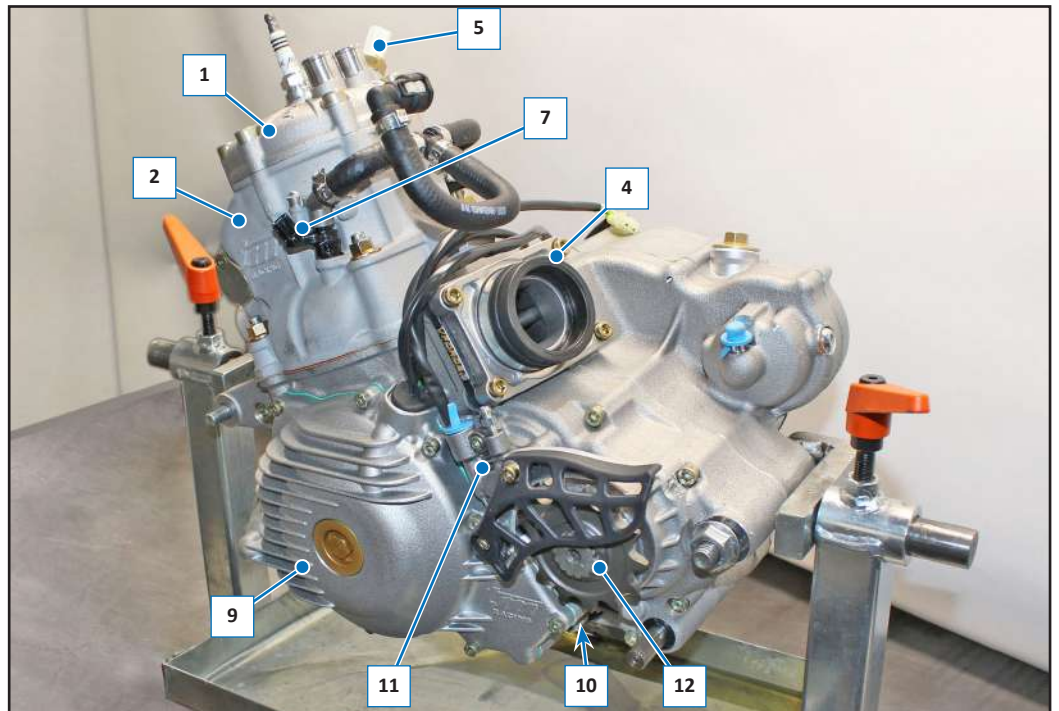

2.3 REMOVING THE PINION COVER

Unscrew the two screws (1).

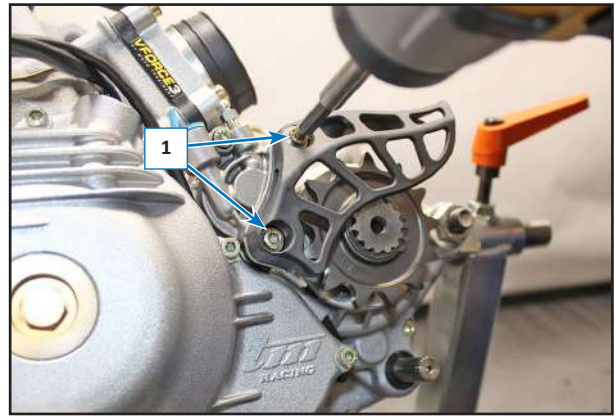

Remove the pinion cover (2) and the protection bracket (3).

NOTE: Upon reassembly, make sure that the two bushes (4) are present on the pinion cover (2). Tighten the two screws (1) with a torque of 15 Nm (1,5 kgm, 11,6 ft/lb)

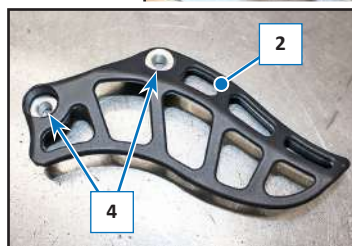
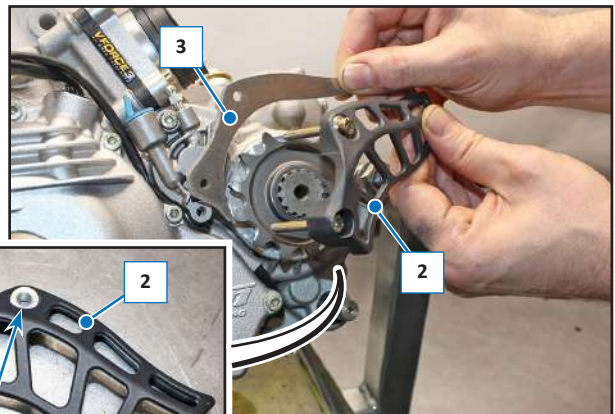

2.4 PINION REMOVAL

Remove the pinion cover casing, as described in the relative paragraph.

Remove the seeger ring (1).

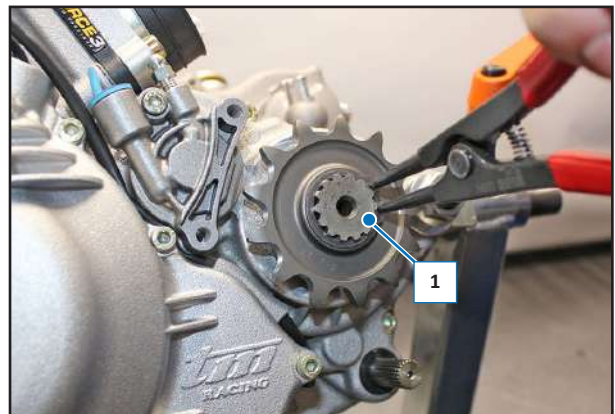

Remove the pinion (2).

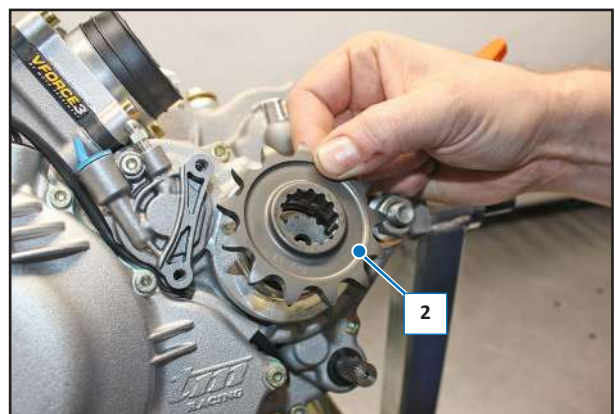

2.5 TEMPERATURE SENSOR REMOVAL

Unscrew the sensor (1) and remove it from the head.

Check that the OR gasket (2) is not damaged.

When refitting, smear the thread (3) with lithium grease and screw with a torque of 30 Nm (3,0 Kgm, 22,12ft/lb)

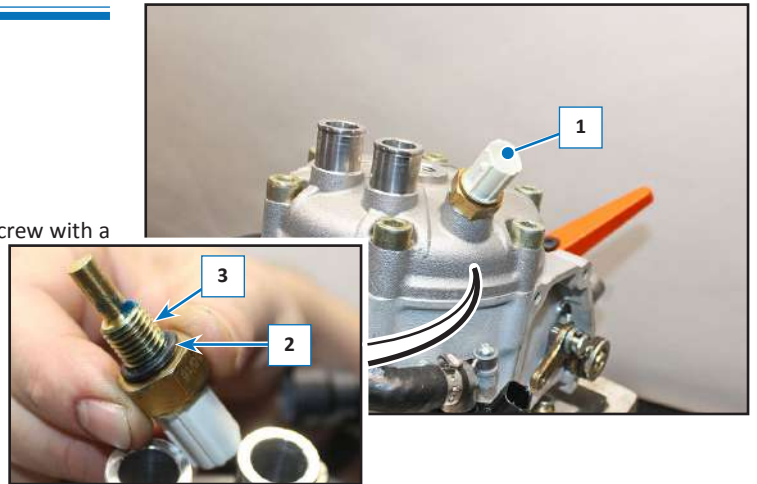

2.6 HEAD REMOVAL

Remove the spark plug and the temperature sensor as described in the relative paragraph.

Undo the screws (1).

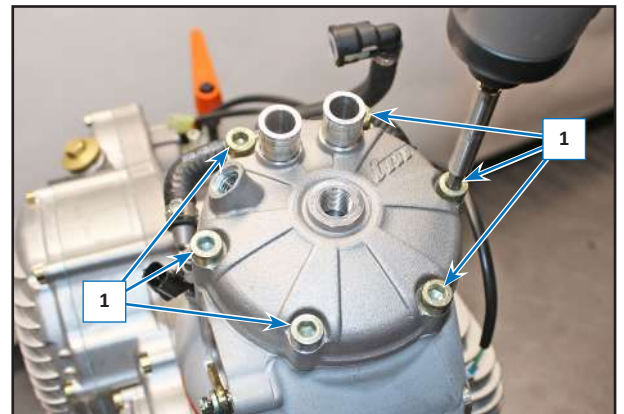

Remove the head (2).

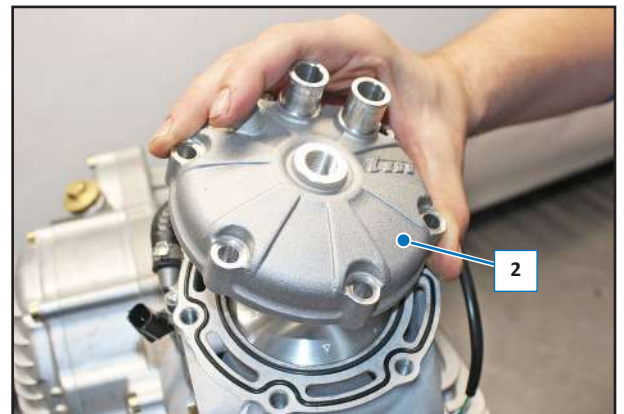

NOTE: Upon reassembly, replace the seals (3) and screw the screws (1) without tightening, then tighten them crosswise with a torque of 20 Nm (2,0 kgm, 14,75 ft/lb).



2.7 INJECTORS DISASSEMBLY (EN-SMR)

NOTE: Before disassembling the injector, the area around the injector must be clean.

2.7.1 Disassembly

Unscrew the two screws (1).

Collect the two Teflon washers (2) for each screw.

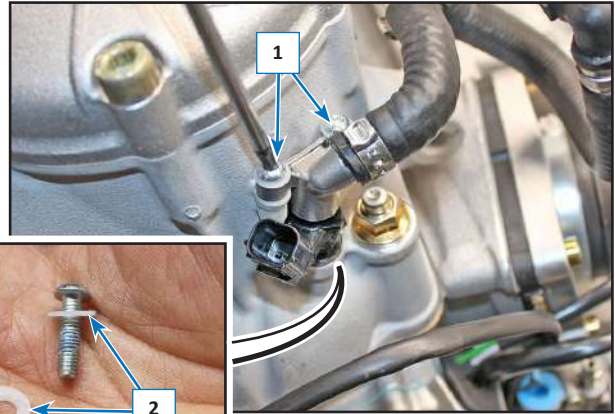
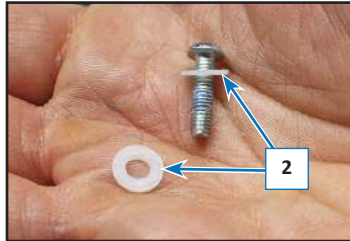

Remove the injector (3).

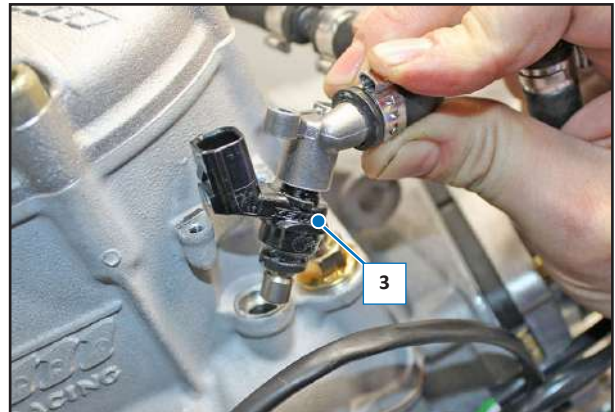

Remove the injector (3) from the duct (4), clean it and put it in a plastic bag so that it does not get dirty.

If the duct (4) with its piping must also be dismantled, also put these in a plastic bag so that they do not become dirty.

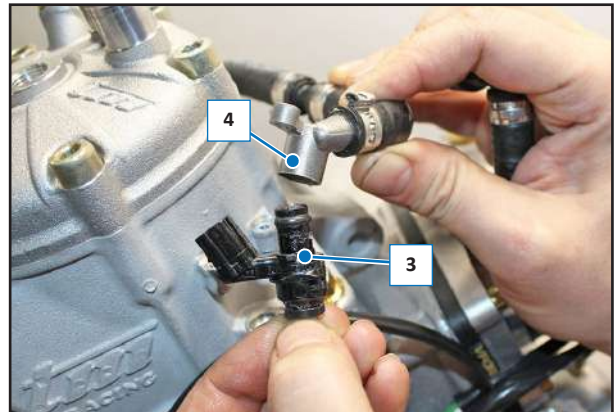

2.7.2 Reassembly

Check the condition of the “OR” gasket (5) if damaged or dry replace the injector.

Grease the part (6) and (7) of the injector with lithium grease.

Reassemble the injector (3) in the duct (4).

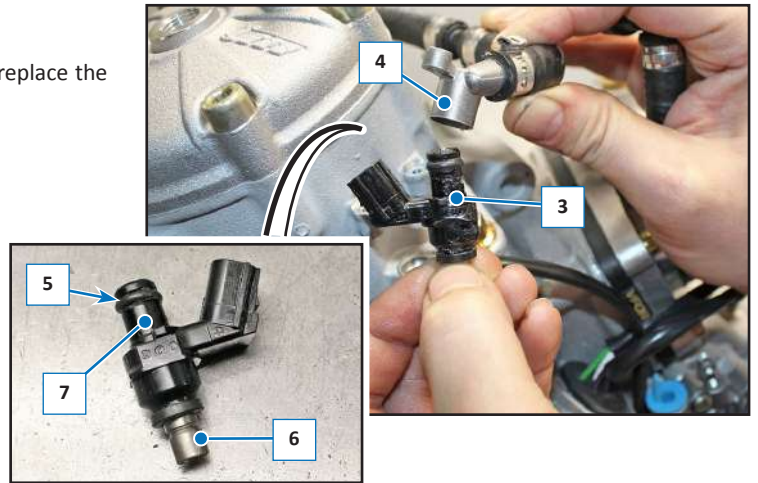

Mount the injector (3) in the seat (8) of the cylinder.

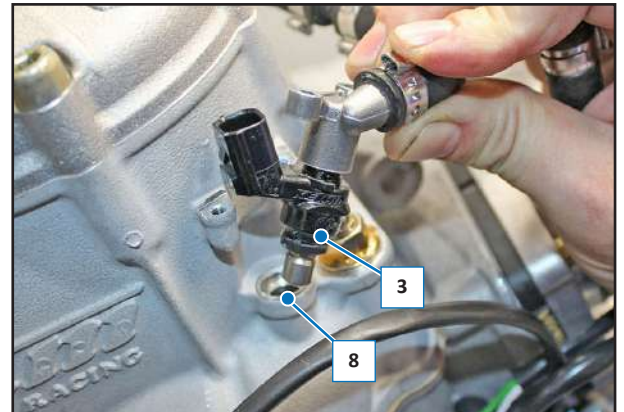

Put abundant loctite 243 on the threads of the two screws (1) then reassemble them making sure that the Teflon washers (2) are positioned as shown in the figure. Tighten so that the screw is packaged with the washers and then tighten another 1/4 turn.

NOTE: If the Teflon washers (2) are damaged, replace them.

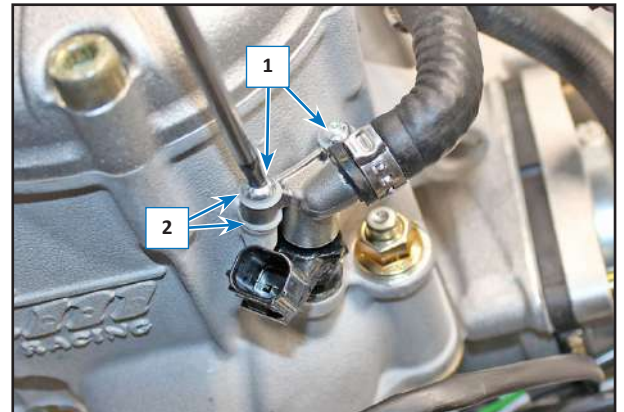

2.8 CYLINDER AND PISTON

2.8.1 Cylinder and piston removal

Remove the head and injectors as described in the relative paragraphs.

NOTE: The drain valve nut (1) must be screwed or unscrewed only when the valve has to be overhauled and only with the cylinder removed.

Do not act on the nut (1) with the cylinder mounted as there may be adjustment problems.

Unscrew the nuts (2) as follows:

- 1) Loosen the nuts (2);
- 2) Completely unscrew the nuts (2).

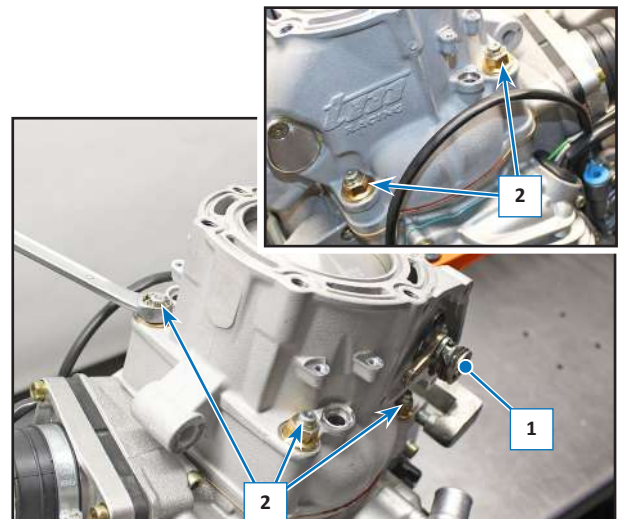

Remove the cylinder (3) by sliding it from the stud bolts.

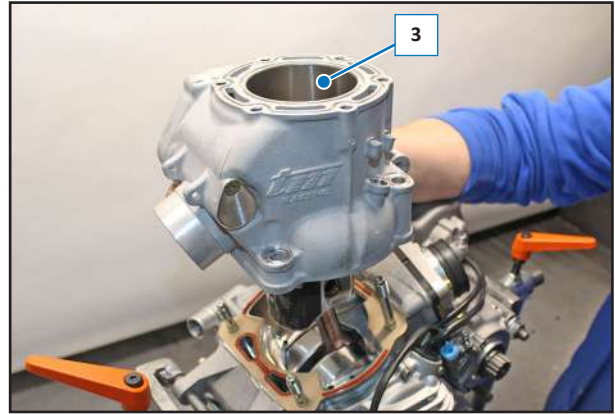

Remove the gasket (4).



Remove the lock ring (5) of the piston (6)

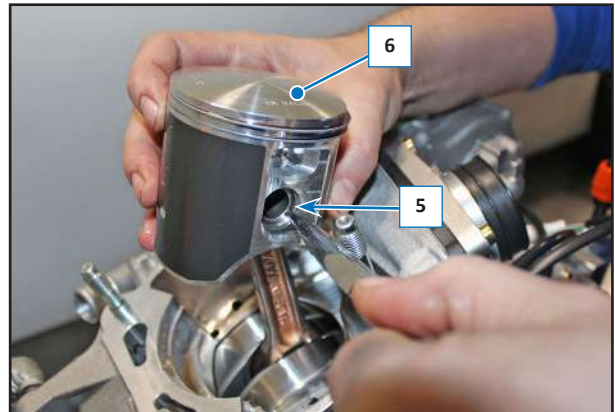

Extract the pin (7) and remove the piston (6).

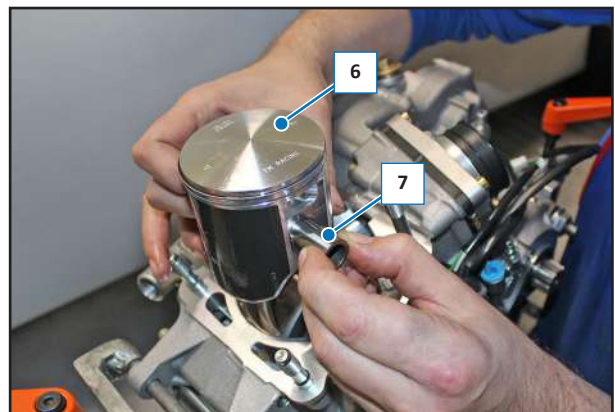

Remove the roller cage (8).

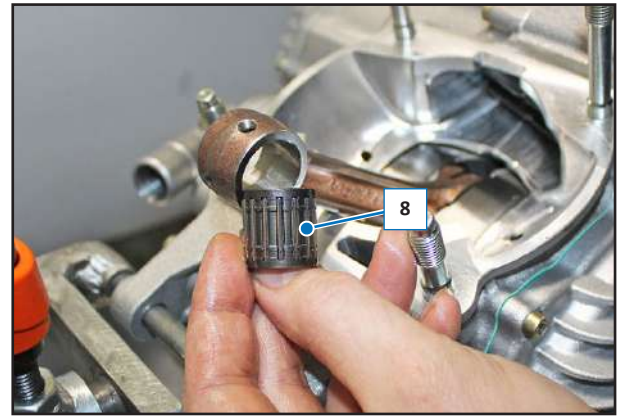

2.8.2 Ring replacement and assembly

Before fitting the new rings on the piston, it is necessary, by means of a file, to “Break the corner” by chamfering on both sides (1) and (2) the upper open part of the ring. An “N” is printed on the upper part.

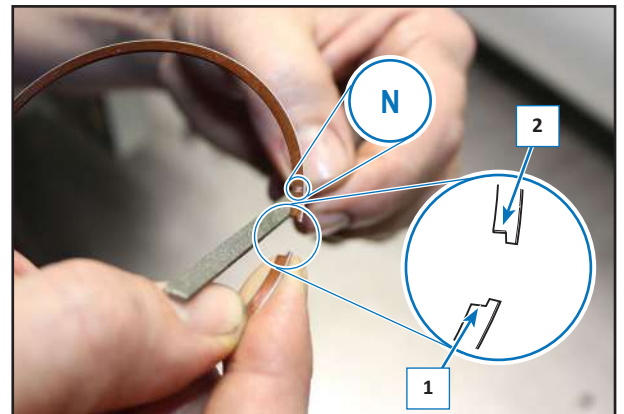

Insert the ring (3) on the cylinder (4).

Turn the ring (3) so that the part with an “N” printed on it is upwards.

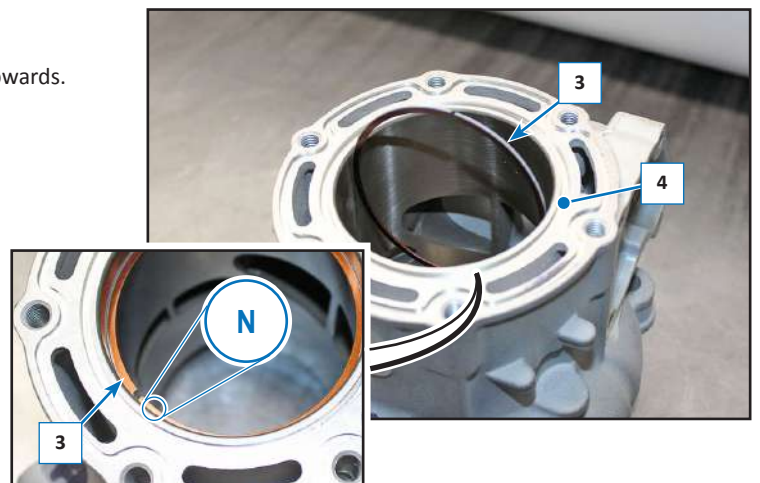

Insert the piston (5) on the cylinder (4) so that the ring (3) is positioned level.

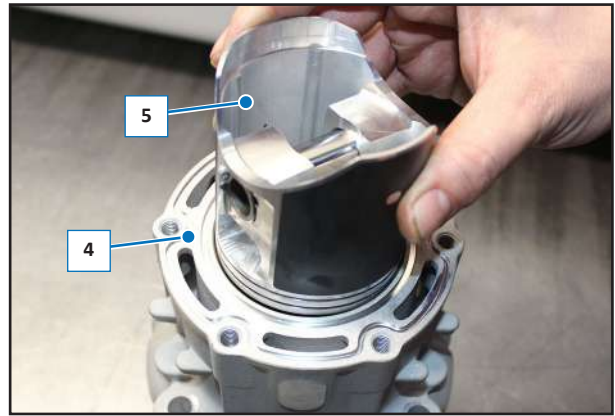

With a thickness gauge (6) check the "Thermal GAP" ring opening distance (3) which must be $0,60 \div 0,65$ mm ($0,0236 \div 0,0255$ in).

If necessary, using a file, restore the measurement and repeat the check procedure.

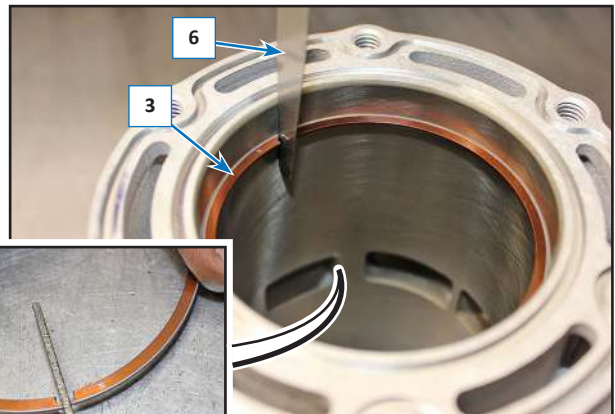

2.8.3 Ring mounting

Clean the housing (1) of the rings on the piston from any carbon deposits.

NOTE: Apply engine oil on the rings before mounting them on the piston. Be careful not to scratch the piston when re-mounting. Do not widen the rings excessively during mounting, so that they are not damaged.

Install the rings (2 and 3) positioning them with the face engraved with an "N" on the upper part.

Check that the rings rotate freely around the piston and are not obstructed. Position the open part of the ring (2) and the adherent part of the ring (3) so that they are 180° apart as indicated in the figure, before re-mounting the piston in the cylinder.

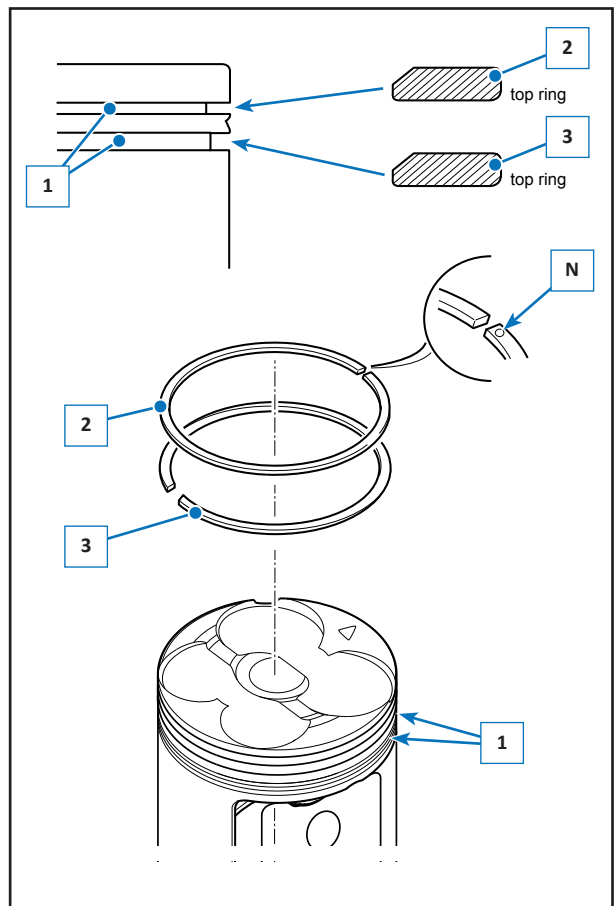

2.8.4 Piston replacement

Remove the piston and cylinder as described in the relative paragraph.

2.8.5 Piston replacement with intact cylinder

Check the integrity of the cylinder barrel, if the barrel is intact and not scored, clean with scotch brite and wash.

Order the piston and rings of the same size as the original equipment piston:
tolerance between cylinder and piston $0,09$ mm ($0,0031 \div 0,0035$ in).

Fit the rings on the piston as described in the relative paragraph.

2.8.6 Piston replacement with cylinder to be machined

If the barrel of the cylinder is scratched, it is necessary to lap the barrel itself.

After processing it is necessary to measure, with a micrometer (1) for insides, the diameter of the barrel crosswise at 90° first at a distance of 10 mm (0,393 in) from the top of the cylinder and then at a distance of 20 mm (0,787 in) from the top of the cylinder.

Once the measurement has been carried out, order the piston so that the cylinder and piston coupling is $0,08 \div 0,09$ mm ($0,0031 \div 0,0035$ in).

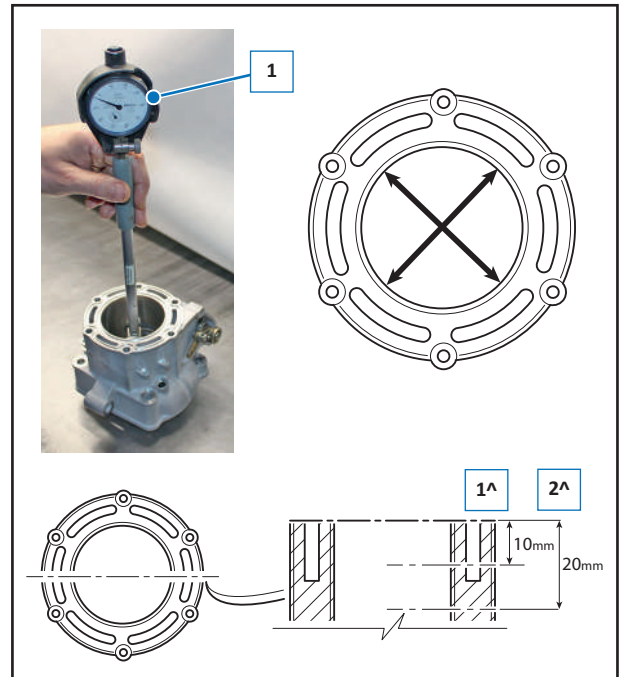

2.8.7 Cylinder replacement

When there is a need to replace the cylinder, the piston must also be replaced so that the cylinder and piston are correctly coupled as described in the previous paragraphs.

2.8.8 Cylinder and piston re-mounting

Check the condition of the roller cage (1), if worn replace and reassemble on the connecting rod.

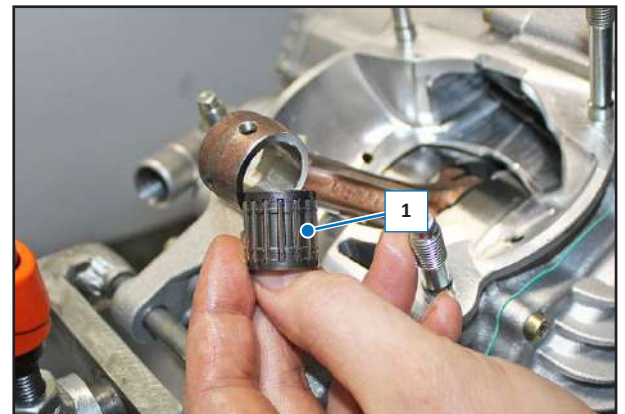

Re-mount the piston (2) on the rod, paying attention that the arrow (3) is positioned towards the exhaust and then insert the pin (4) and relative lock ring (5).

Check that the rings are positioned as indicated in the "Ring replacement and mounting" paragraph.

Oil the cylinder barrel with engine oil.

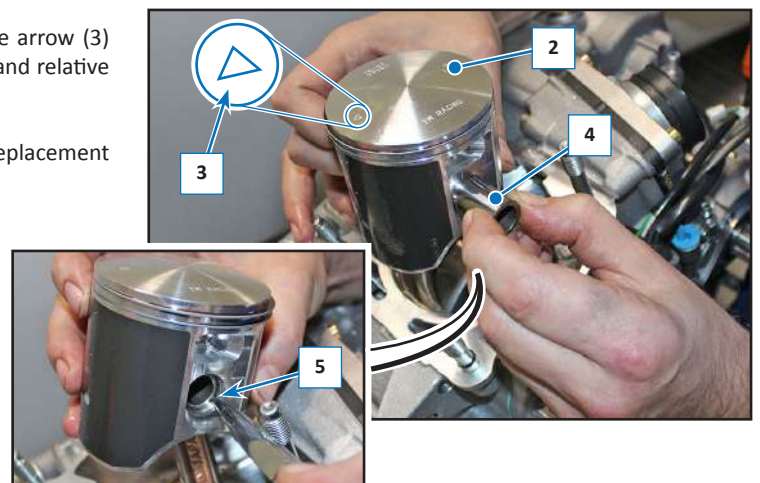

Fit a new gasket (6).

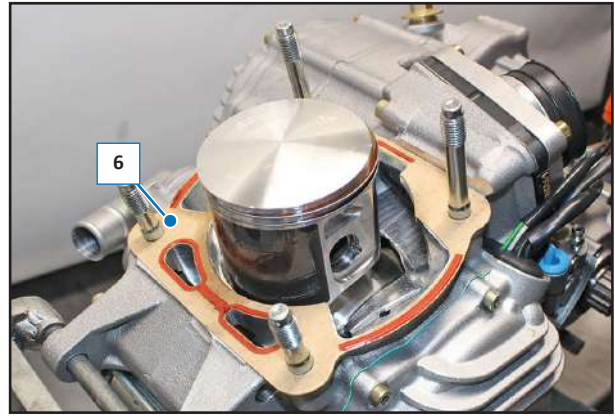

Insert the cylinder (7) onto the studs (8).

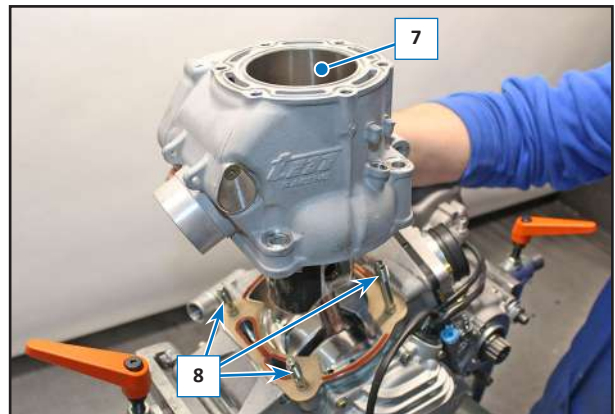

Screw without tightening the nuts (9) then tighten crosswise with a torque of 26 Nm (2,6 Kgm, 19,18 ft/lb).

NOTE: If the cylinder has been replaced, it is necessary to check the squish as described in the paragraph "Checking the squish".

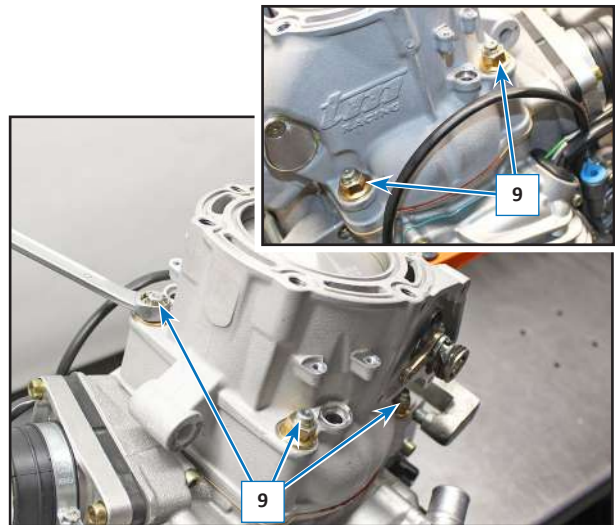

2.9 CHECKING THE SQUISH

Cut a piece of tin as straight as possible of the length equal to the diameter of the cylinder and with a minimum diameter of 3 mm (0,118).

Apply a small amount of grease to the centre of the piston.

Position the tin (1) previously prepared on the grease so that it is aligned with the piston pin.

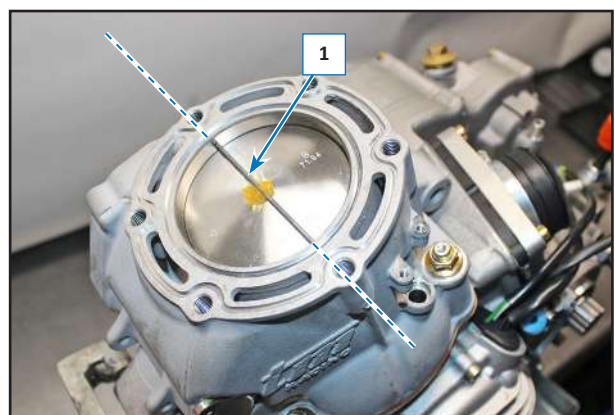

Fit the new gaskets (2) on the upper part of the cylinder (3).

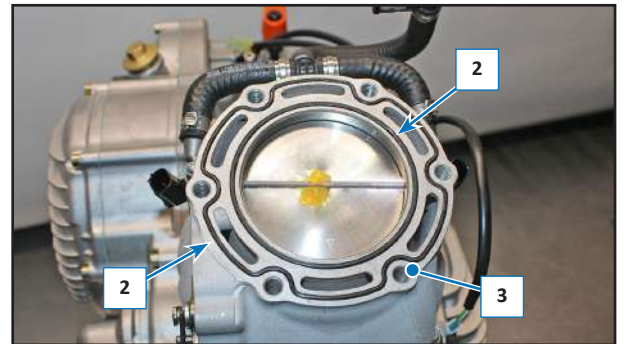

Mount the head (4) on the cylinder (3) and screw the screws (5) without tightening then tighten them crosswise with a torque of 20 Nm (2,0 kgm, 14,75 ft/lb).

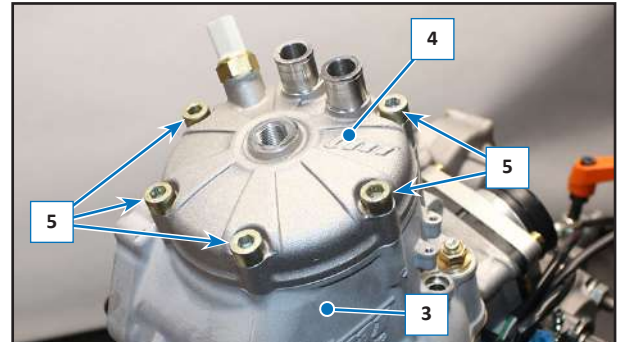

Remove the cap (A) from the generator cover (B).
Check the condition of the gasket (C), if damaged, replace.
Using a socket wrench (6), alternately move the piston, passing repeatedly to the TDC until the resistance of the tin is no longer felt.

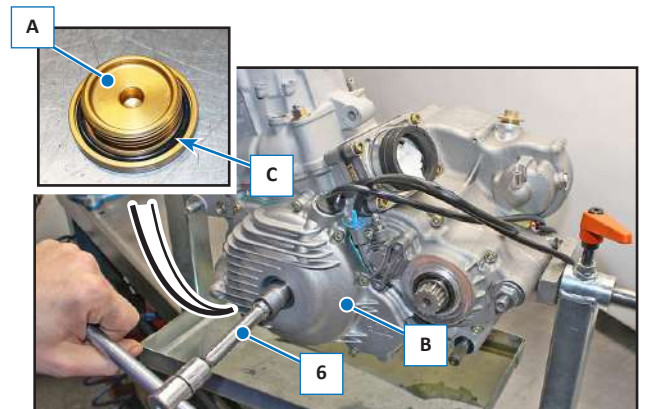

Undo the screws (5) and remove the head (4).

Take the piece of tin (1) from the piston and measure the thickness (squish) which must be between 1,6÷1,7 mm (0,63 ÷ 0,67 in).



NOTE: If the measured measurement is not within the established measurement, the base gasket (7) of the cylinder must be replaced with one of a thickness suitable for the detected measurement.

For example:

- if the measured measurement is greater than 1,7 mm (0.67 in) it will be necessary to insert a gasket (7) with a thickness greater than the one fitted;
- if the measured measurement is less than 1,6 mm (0,63 in) it will be necessary to insert a gasket (7) with a lower thickness than the one installed.

For the gasket replacement operations, refer to the previous paragraphs.

Repeat the squish check operation to verify that it is within the established size.



Refit the cap (A).

2.10 DRAIN VALVE REMOVAL / REVISION

Remove the cylinder as described in the relative paragraph.

Place the cylinder in a vice and unscrew the screws (1) of the cover (2).

Remove the cover (2) and check the gasket (3); if damaged, replace.

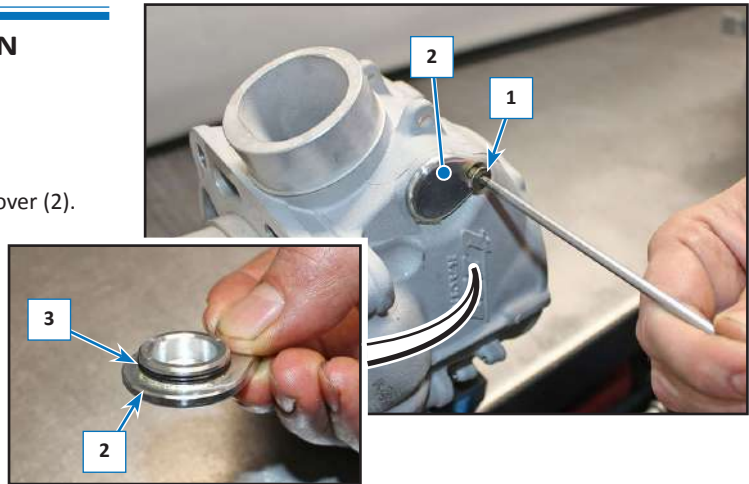

On the opposite side, unscrew the nut (4) which locks the valve control lever (5).

Remove the lever (5).

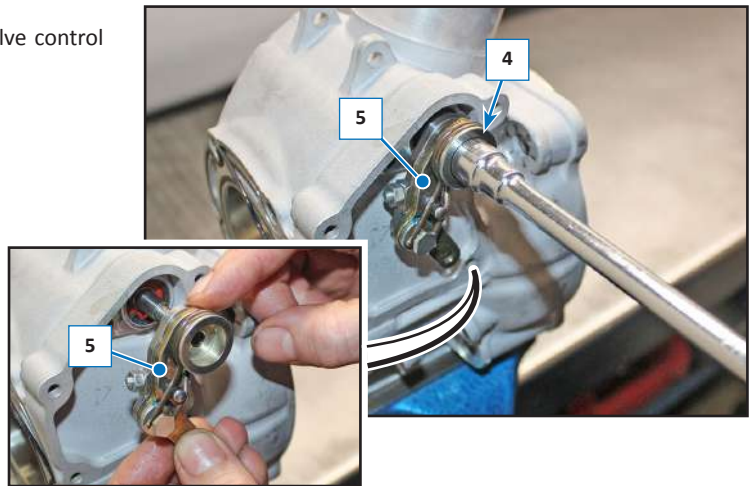

Unscrew the screw (6) securing the bearing support (7).

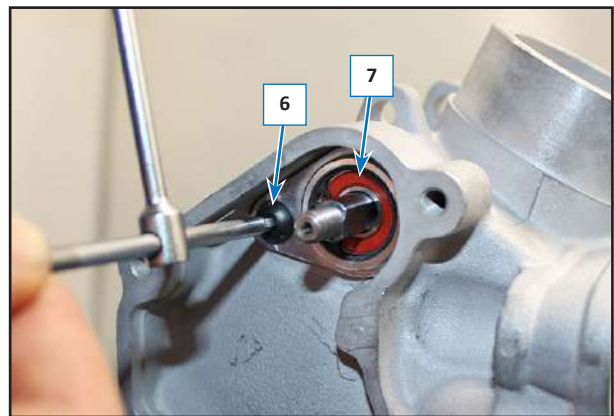

Remove the bearing support (7).

Collect the calibrated washer (8) positioned behind the support (7).

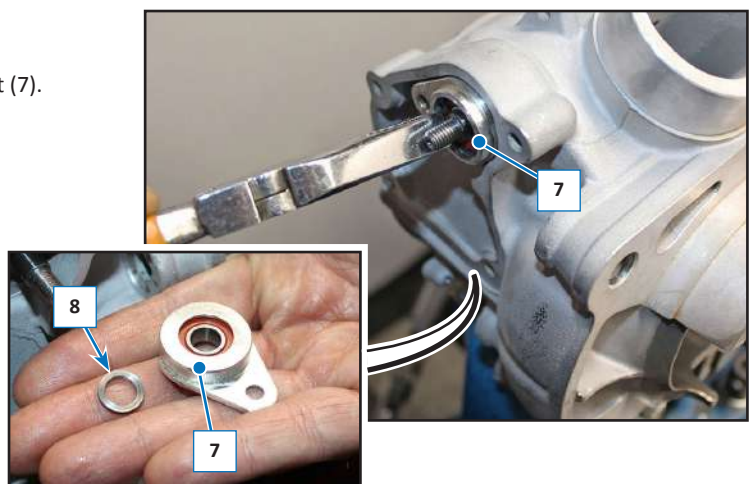

Check the condition of the bearing (9), if damaged, replace by removing the seeger (10).

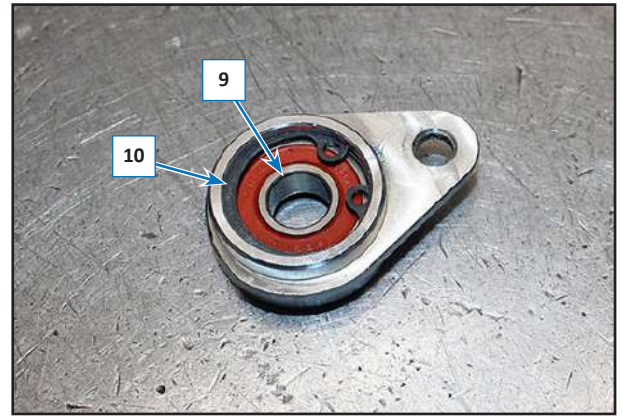

With an aluminum punch (11) and a hammer extract the pin (12) from the opposite side.

Remove the pin (12).

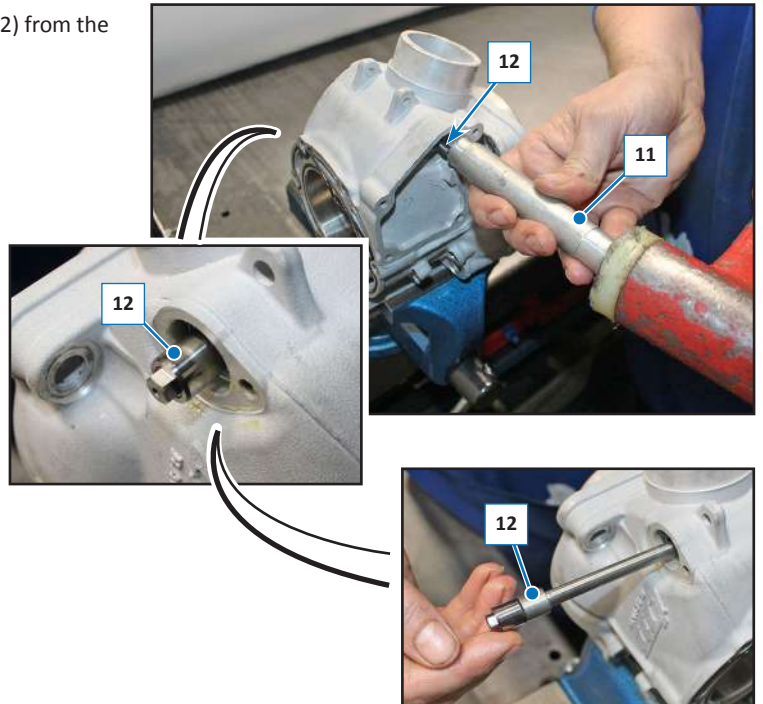

Remove the two valves (13).

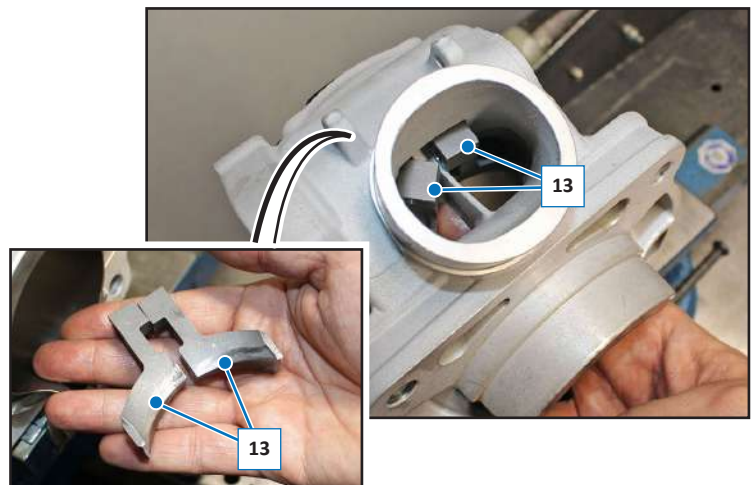

Remove the socket (14).

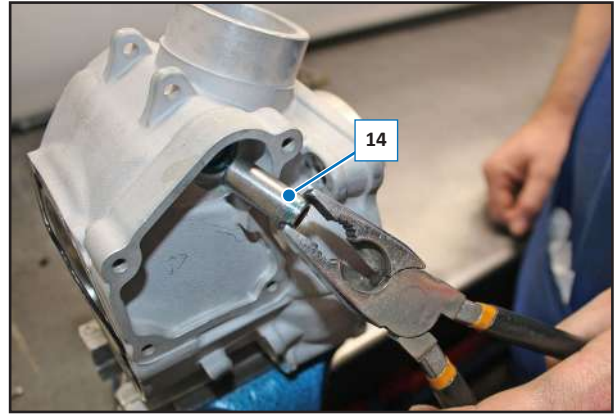

Remove the seal (15) and the roller bearing (16) located behind.

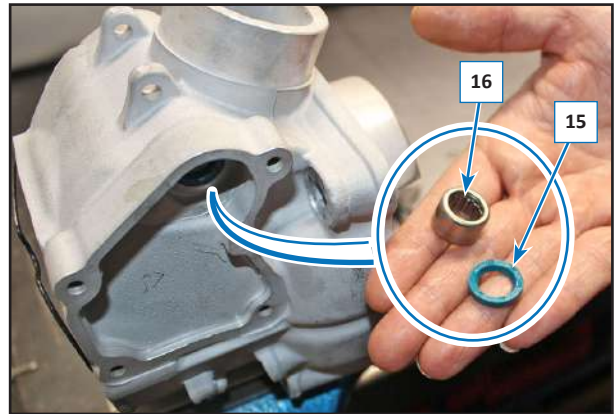

2.10.1 Dismantling the lever (5)

Withdraw the spring (17) from the pin (18) of the lever (5).

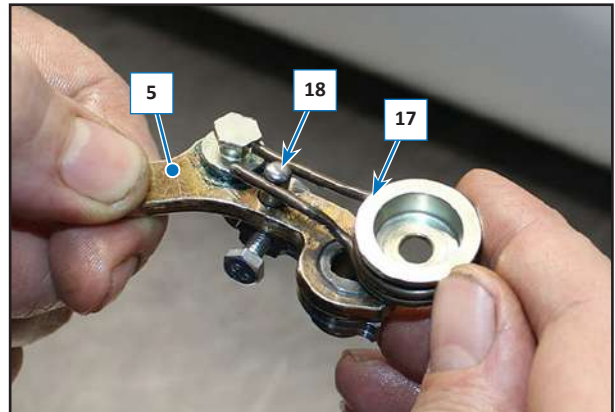

Undo the screw (19) to disassemble the lever.



2.10.2 Refitting the lever (5)

Put graphite grease around the pin (20) and on the screw (19) without dirtying the thread.

Put loctite 243 on the thread (21)

Recompose the lever and tighten the screw (19).

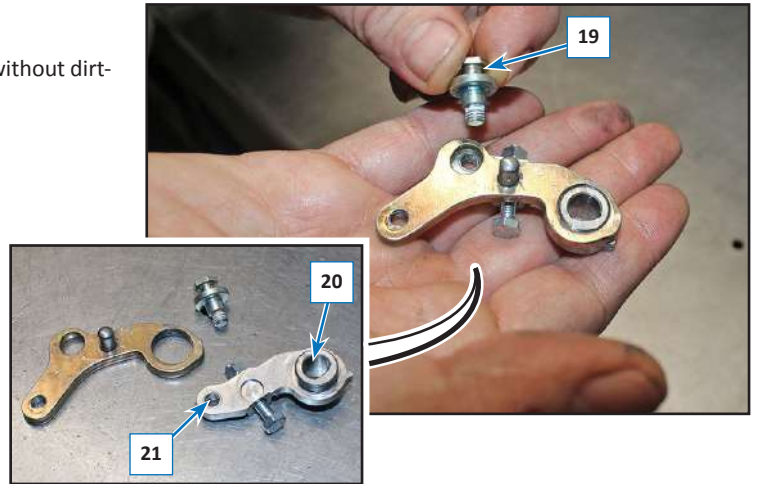

Insert the spring (17) in the pin (18) and on the screw (19).

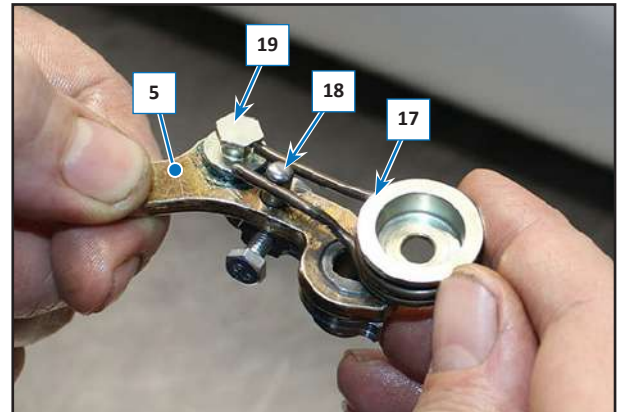

2.10.3 Reassembly of the valve (13)

Reassemble the roller bearing (16) and the seal (15) with the printed side facing out.

NOTE: If the seal (15) is damaged, replace.

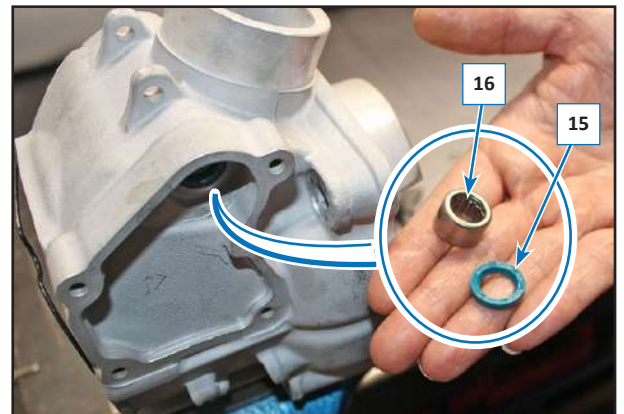

Smear the socket (14) with graphite grease and reassemble it in the cylinder.

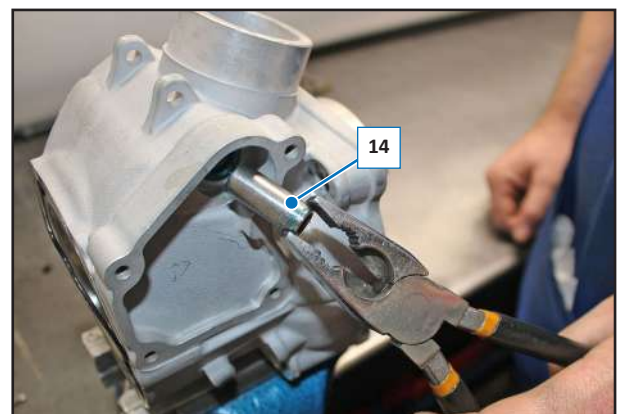

Insert the two valves (13) in the cylinder seat, taking care to position the part of the valve cutting edge (chamfered part) towards the inside of the cylinder.

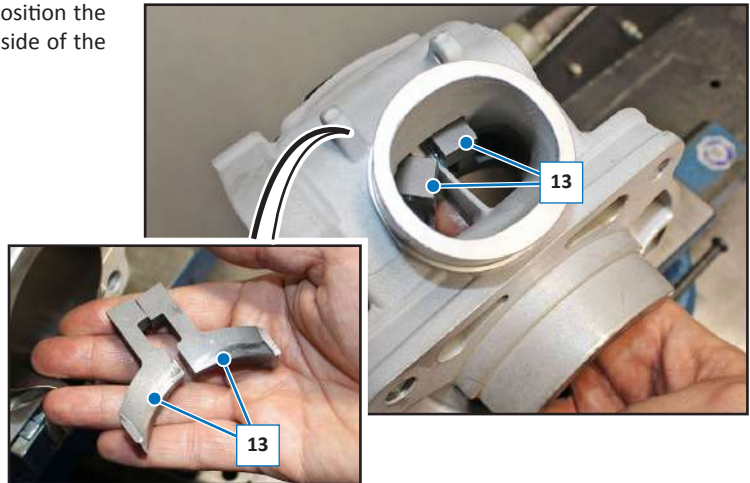

Grease the pin (12) with graphite grease and reassemble it in the cylinder.

To insert the pin (12) completely use an aluminum punch and lightly tap on the head of the pin.

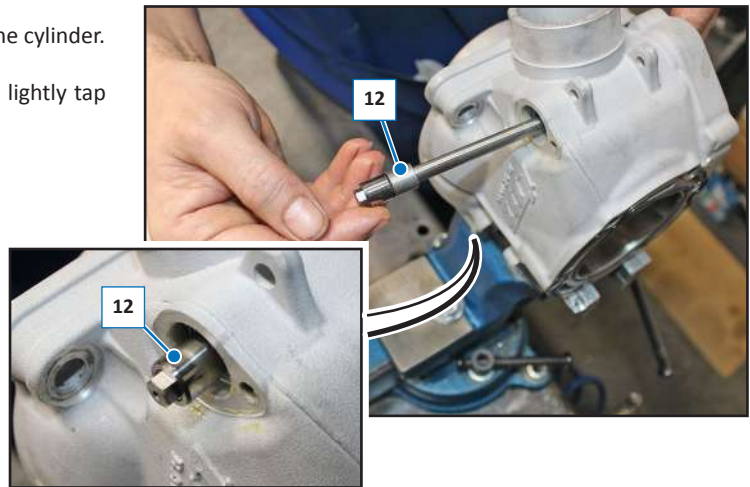

Refit the cover (2) by tightening the screw (1).

NOTE: Check that the gasket (3) is not damaged otherwise replace.

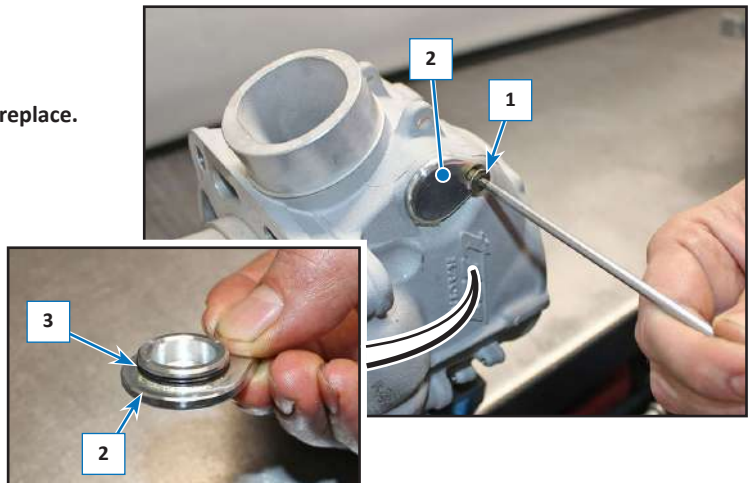

Refit the calibrated washer (8) on the pin (12) and reassemble the bearing support (7) by tightening the screw (6).

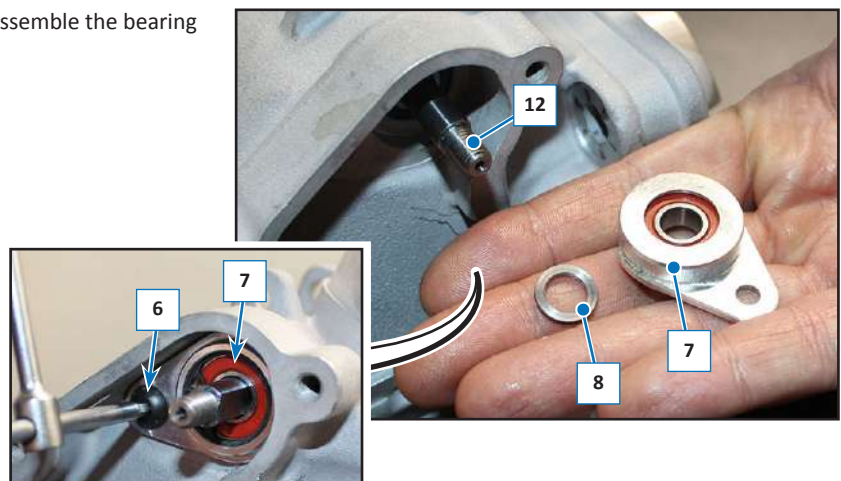

Insert the lever (5) into the pin (12).

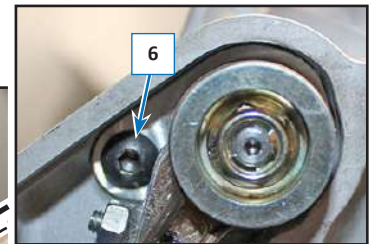
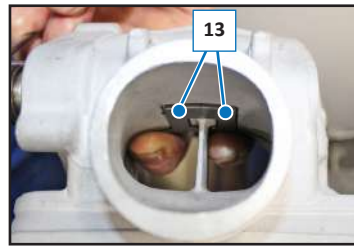
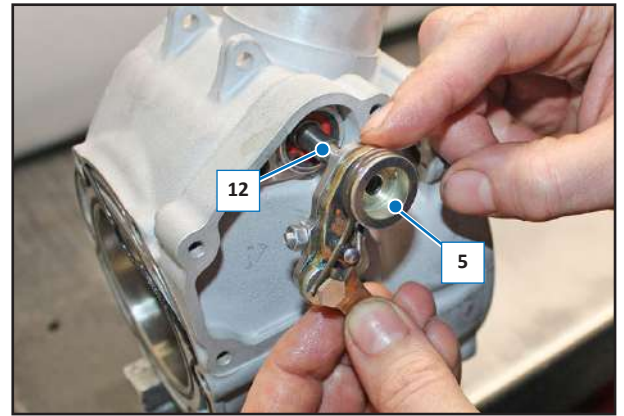

With two fingers hold the valve (13) in the fully open position, insert an Allen key (22) on the screw (6) and screw the nut (4).

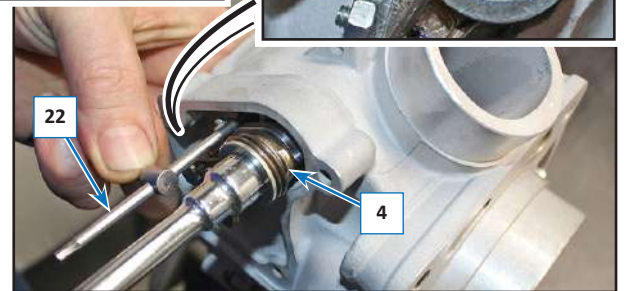

2.10.4 Valve height adjustment in closed position

With the valve completely closed, the distance between the upper surface of the cylinder (23) and the chamfered part of the valve (24) (Cutting edge) must be 56 mm; for the adjustment loosen the nut (25) and act on the screw (26), having reached the measure of 56 mm tighten the nut (25).

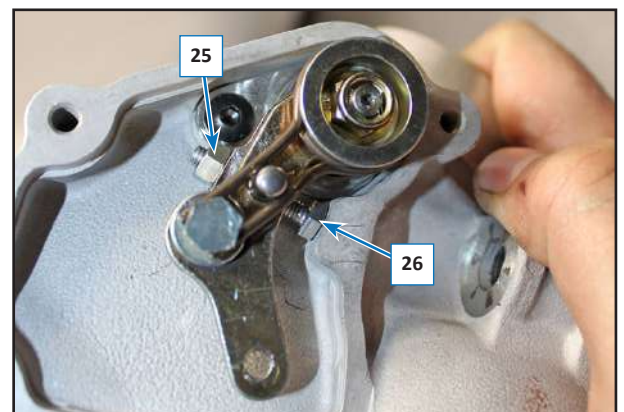
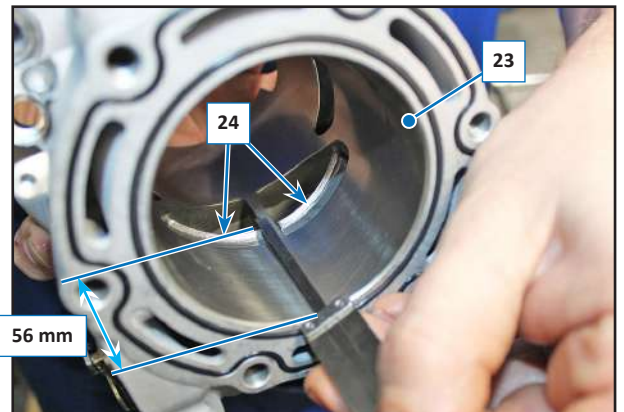

2.11 REED VALVE PACK

Check and/or replace the blades.

Unscrew the screws (1) that fix the external frame (2) of the reed valve pack.

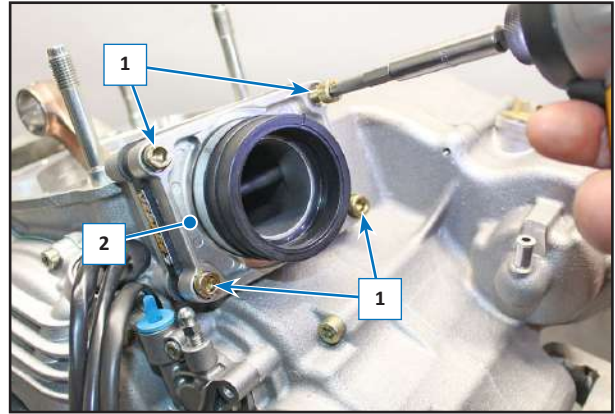

Check the rubber fitting (3) on the carburettor/throttle body, if damaged, cracked, etc. replace.



Check the OR gasket (4); if damaged, replace.

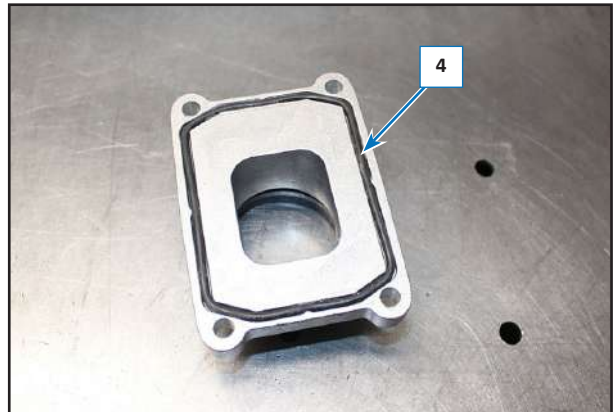

Remove the reed valve pack (5) and the relative gasket (6); if damaged, replace.

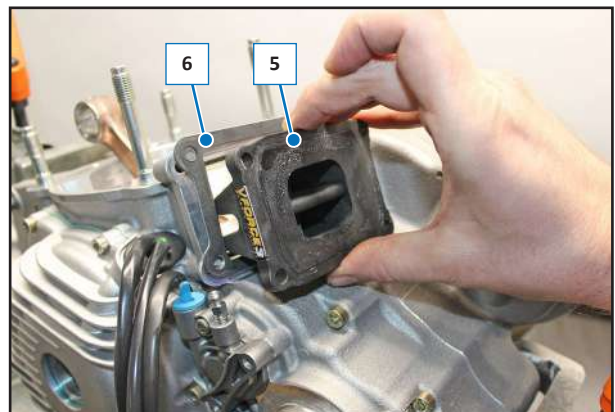

Remove the internal frame (7).

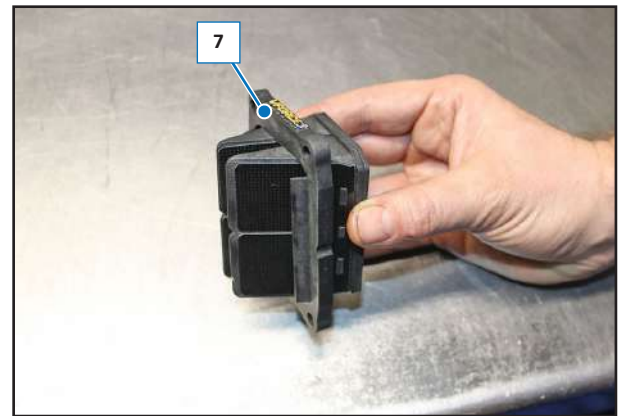

Remove the external blades (8).

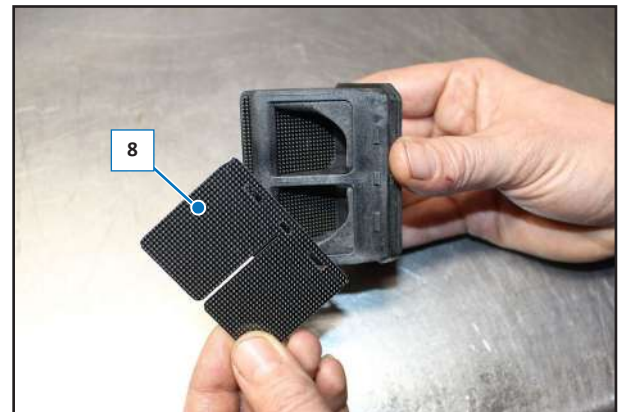

With a screwdriver, slide out the two internal stops (9).



Remove the internal blades (10).

Check the state of the blades, if chipped or deformed, they must be replaced.

To reassemble, proceed in reverse order of disassembly.

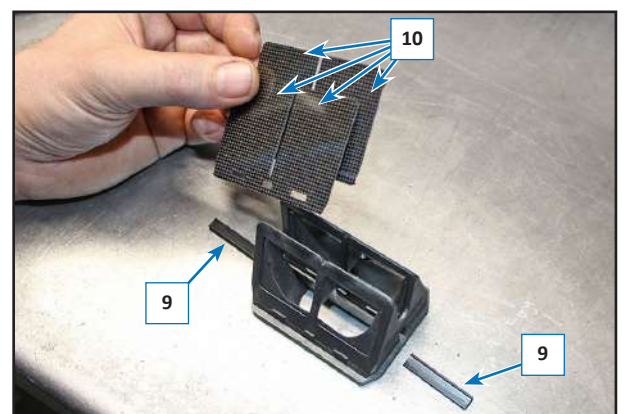

2.12 CLUTCH

2.12.1 Clutch actuator removal

Remove the sprocket cover as described in the relative paragraph.

Unscrew the screw (1) and remove the actuator (2).

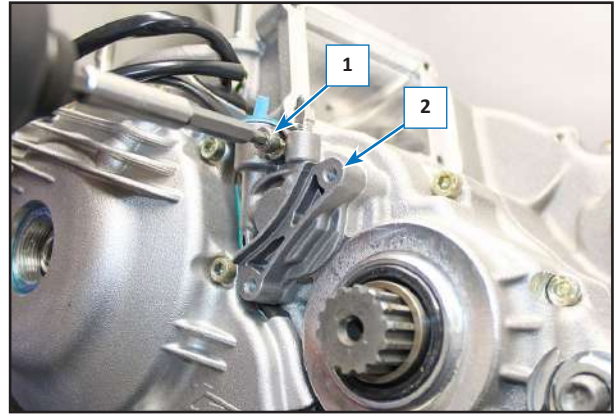

2.12.2 Actuator dismantling

Remove the piston (3).

Check the conditions of the OR gaskets (4 and 5); replace them if ruined.

NOTE: On re-mounting, lubricate the gaskets with clutch oil.

Re-mount everything, proceeding in the opposite order to disassembly.

Tighten the screws (1) with a torque of 8 Nm 0.8 kgm/ 5.9 ft/lb.

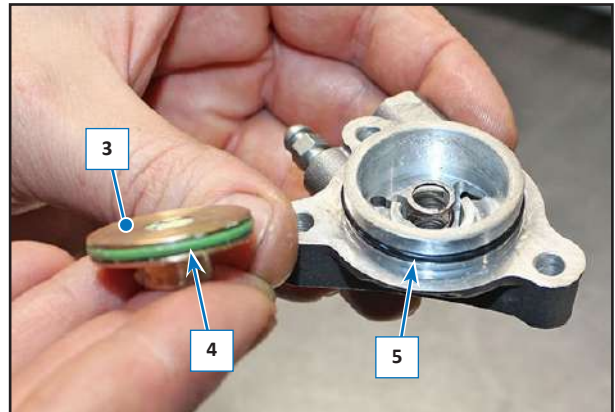

2.13 GEAR SENSOR

Remove the flywheel casing as described in the relative paragraph.

Unscrew the two grub screws (1).

Remove the sensor (2).

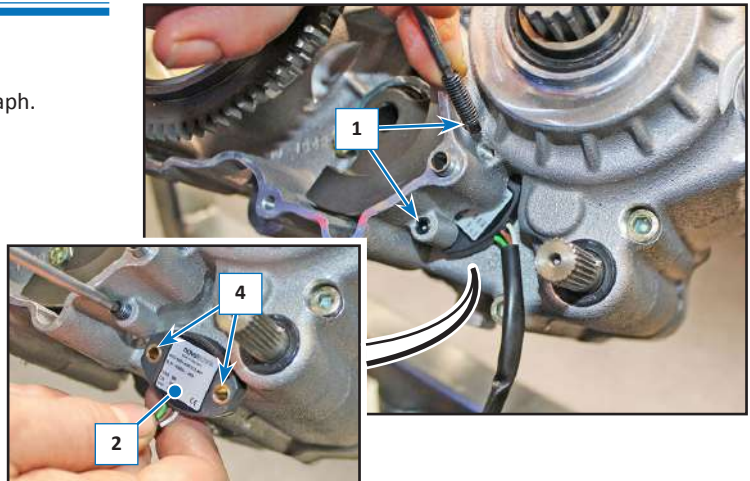

NOTE: Reassemble everything in the reverse order of disassembly, taking care to position the non-threaded part of the grub screws (1) in the brass bushes (4).

Position the cable harness (5) as originally and reassemble the flywheel housing.

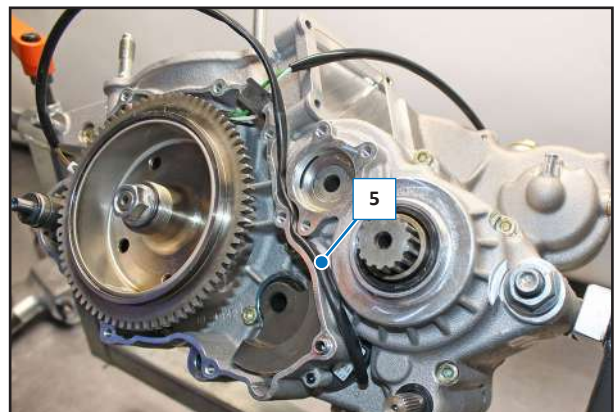

2.14 FLYWHEEL REMOVAL

2.14.1 Flywheel cover

Unscrew the M5-L25 screws (1).

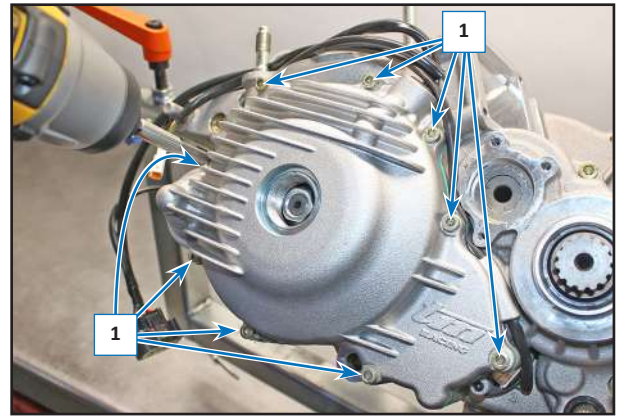

Remove the flywheel cover (2).

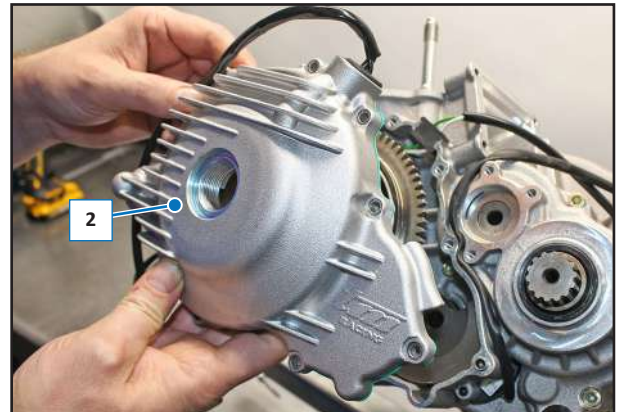

Remove the gasket (3).

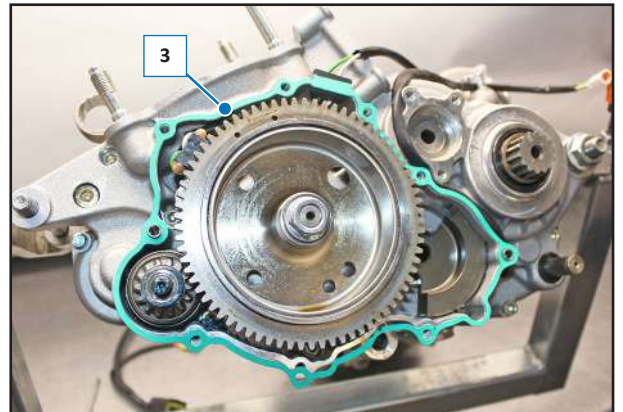

Retrieve the two centring bushes (4).

NOTE: On re-mounting, check that the two centring bushes (4) are positioned correctly. Clean the surface of the cover and the split crankcase of any residues and check that the gasket (3) is not damaged, otherwise replace. Tighten the screws (1) with a torque of 8 Nm (0.8 kgm/ 5.9 ft/lb).

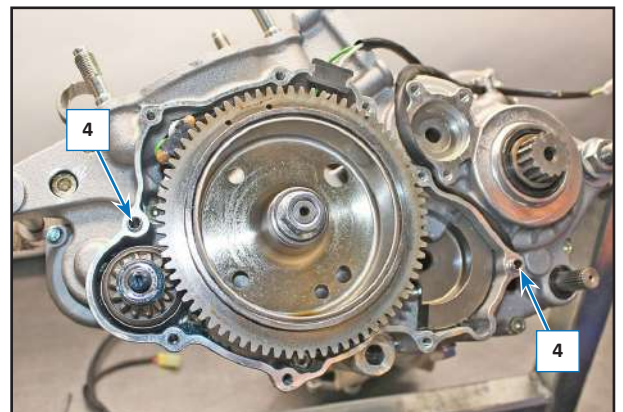

2.14.2 Stator
Disassembly

Remove the flywheel cover as described in the relative section.

Unscrew the screws (1) that secure the stator (2).
 Unscrew the screws (3) and remove the stop plate (4).
 Remove the stator (2) with the relative cabling.

Mounting

Re-mount the stator (2), tightening the screws (1) to a torque value of 8 Nm (0.8 Kgm - 5.9 ft/lb + Loxeal 82-33).

Make sure the rubber cap (5) is fitted correctly on the cover and then tighten the two screws (3) of the stop plate (4) with a torque of 5 Nm (0.5 kgm, 3.68 ft/lb).

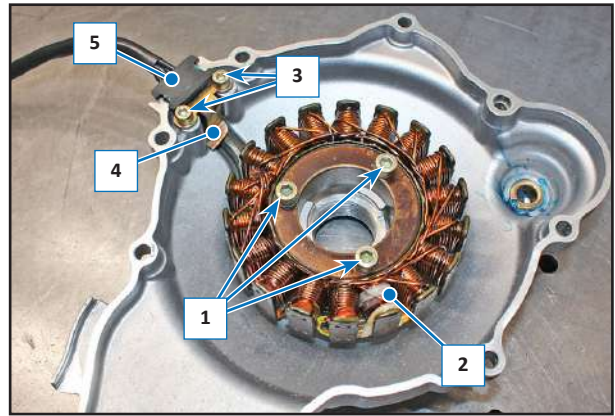
2.14.3 Pick-up

Remove the rotor as described in the relative paragraph.

Unscrew the two screws (1) and remove the pick-up (2).

On re-mounting, check that the washers notched under the screws (1) are positioned correctly.

Tighten the two screws (1) with a torque of 8 Nm (0.8 kgm, 5.9 ft/lb) + Loctite 243.

Make sure the rubber cap (3) is fitted correctly on the guard.

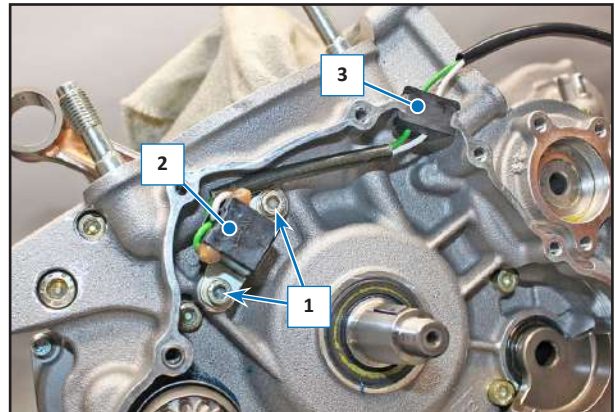
2.14.4 Rotor
Disassembly

Block rotor rotation (1) and use an impact gun to loosen the nut (2) with relative curve washer (3).

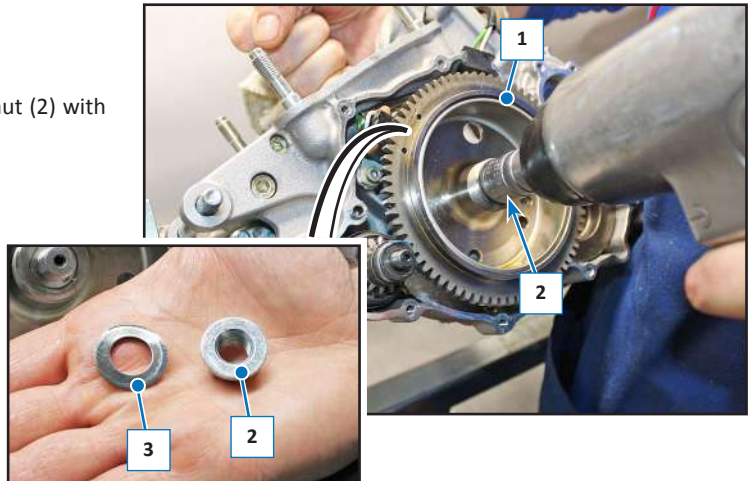

Screw the extractor (4) onto the thread of the rotor (1) and tighten the screw (5) to detach the rotor (1) from the crankshaft.

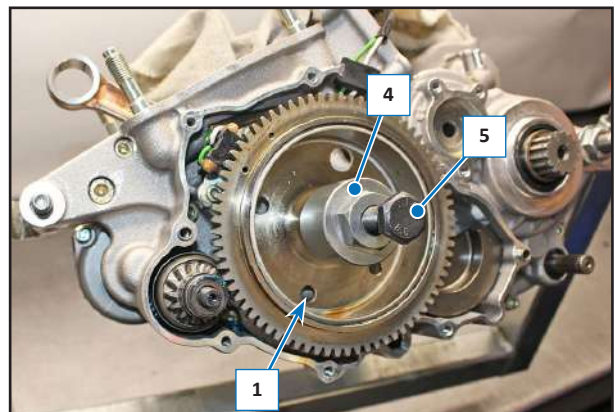

Remove the complete rotor (1).

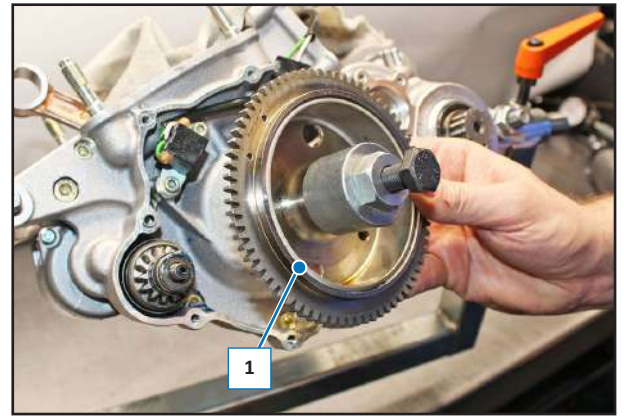

Retrieve the key (6).



Re-mounting

Make sure the key (6) is properly positioned in its housing.



Re-mount the fly wheel (1).

Tighten the nut (2) with relative curve washer with a torque of 60 Nm (6 kgm/ 44.2 ft/lb).

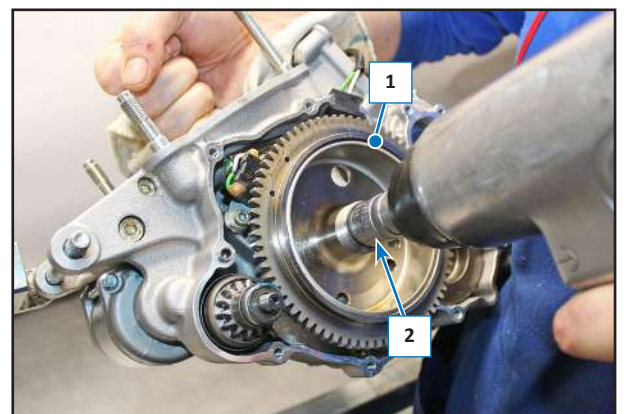

2.15 STARTER MOTOR

2.15.1 Disassembly

Remove the flywheel cover, as described in the relevant paragraphs.

Remove the Bendix starter (1).

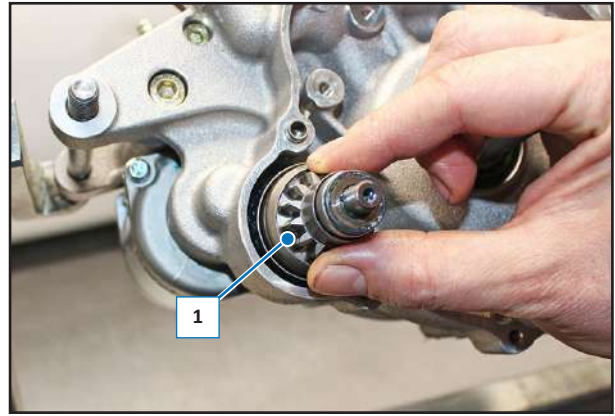

Unscrew the two starter motor fastening screws (2).

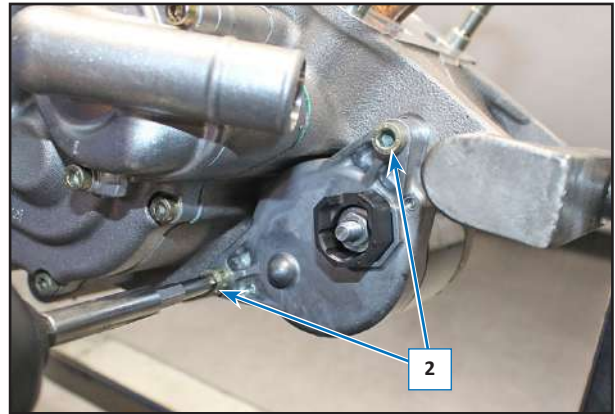

Remove the starter motor (3).

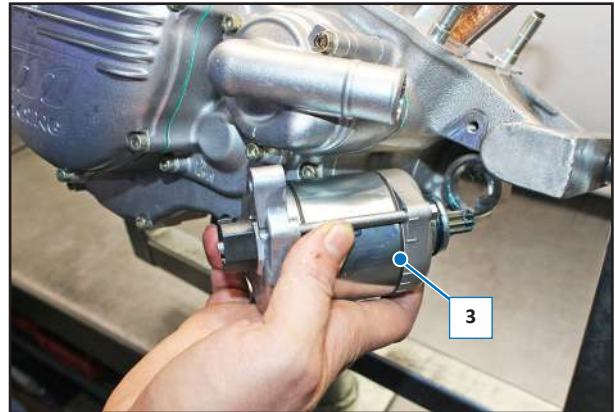

2.15.2 Re-mounting

Check the status of the "OR" gasket (4) positioned on the starter motor (3); replace it if ruined.

Lubricate the gasket (4) with generic grease and then mount the starter motor (3).



Tighten the screws (2) with a torque of 10 Nm (1,0 kgm, 7,38 ft/lb).

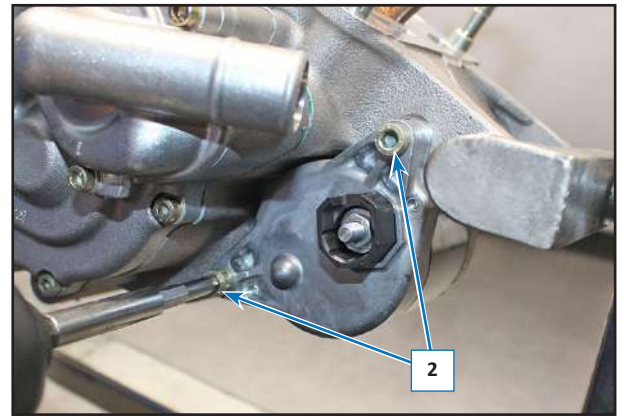

Grease the bronze bush (5) with graphite grease.

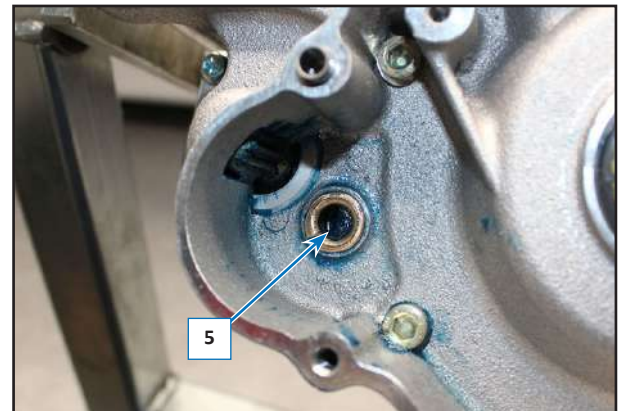

Grease the gears (6) of the Bendix (1) and reassemble it in the bronze bush (5).

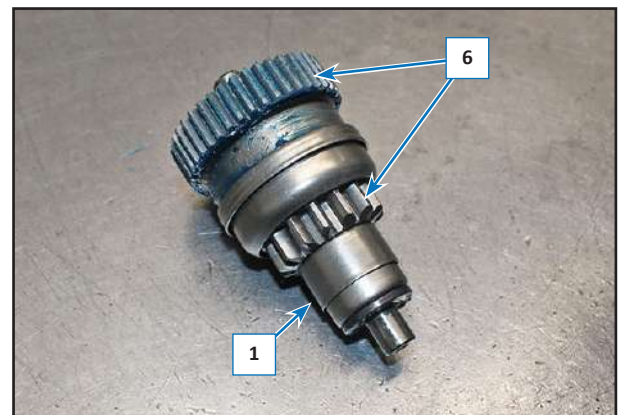

2.16 WATER PUMP

2.16.1 Replacing the sealing gasket

It is possible to replace the water pump seal without removing the transmission card.

Unscrew the screws (1) on the pump cover (3); the screw (1a) is the system drain screw and is equipped with an aluminum washer (2).

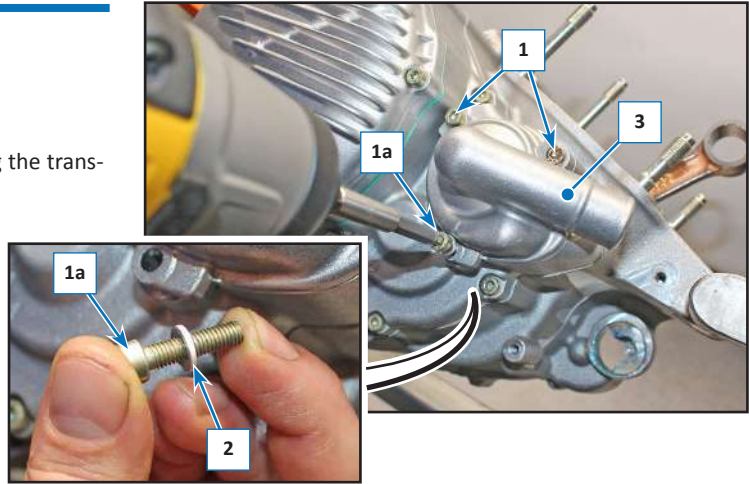

Remove the cap (A) from the generator cover (B). Check the condition of the gasket (C), if damaged, replace. Insert a "T" wrench (7) through the flywheel cover to block the rotation of the crankshaft.

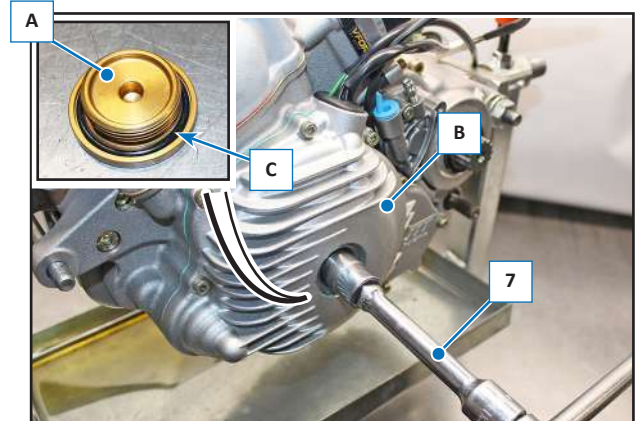

Unscrew the impeller (8) of the pump.

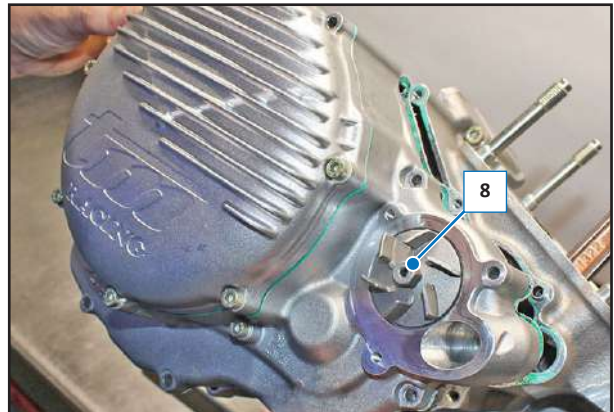

Remove the seal (9) with a screwdriver and replace it.

NOTE: Lubricate the new seal (9) with engine oil before fitting it.

Screw the impeller (8), greasing the thread, with a torque of 6 Nm (0,6 kgm, 4,42 ft/lb), blocking the rotation of the motor shaft with the key (7).

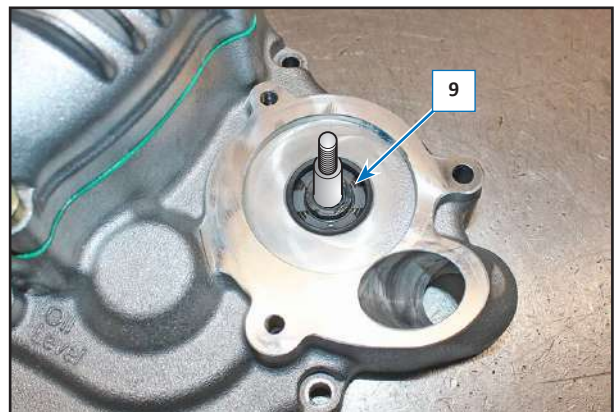

Check the condition of the gasket (4) if damaged, replace.

Refit the pump cover (3) by tightening the screws (1) with a torque of 8Nm (0,8 kgm, 5,9 ft/lb) by replacing the aluminum washer (2) of the screw (1a).

Refit the cap (4).



2.16.2 Water pump removal

Undo the screws (1); the screw (1a) is the system drain screw and is equipped with an aluminum washer (2).

Remove the pump cover (3).

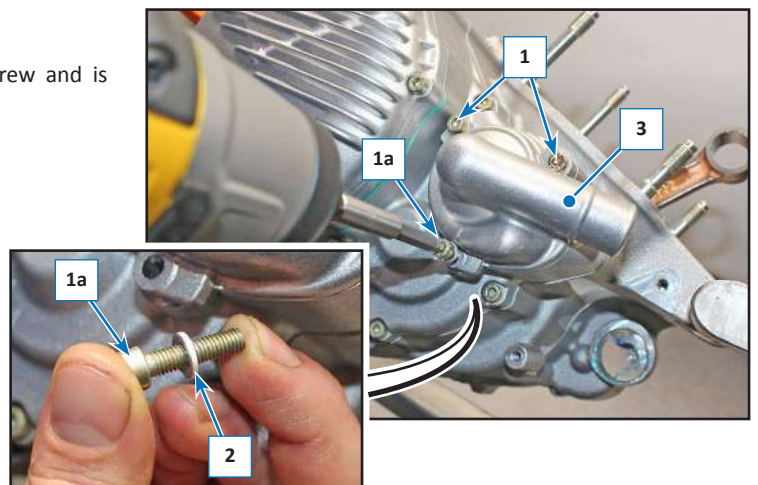

Check the condition of the gasket (4) if damaged, replace.

Remove the transmission cover (5) as described in the relative paragraph.

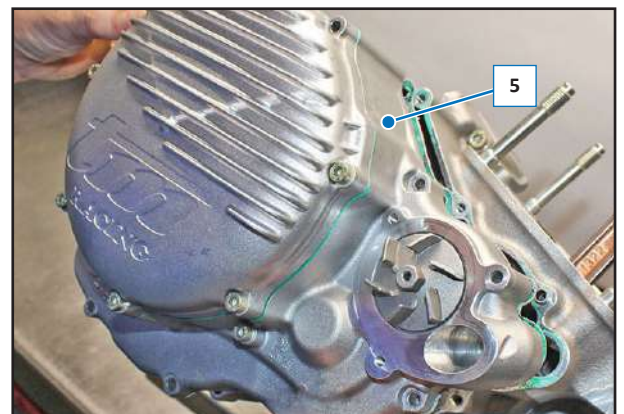

Put aluminum jaws (6) in a vice and lock the shaft (7) of the water pump.

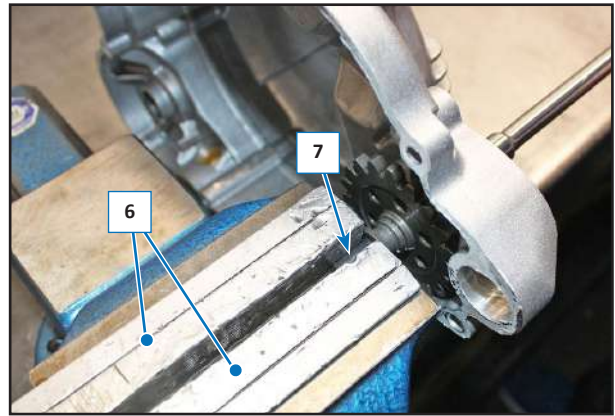

Unscrew the impeller (8).

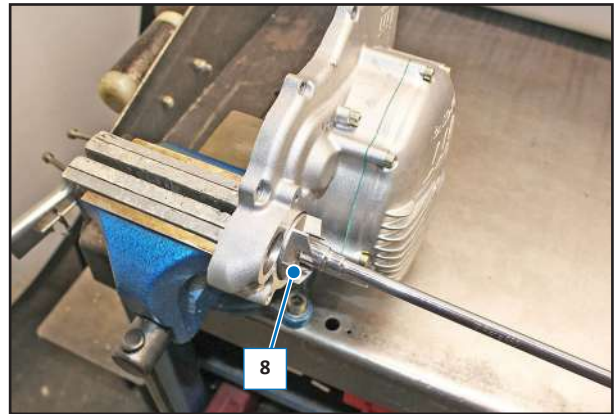

Remove the shaft (7) from the crankcase (5).

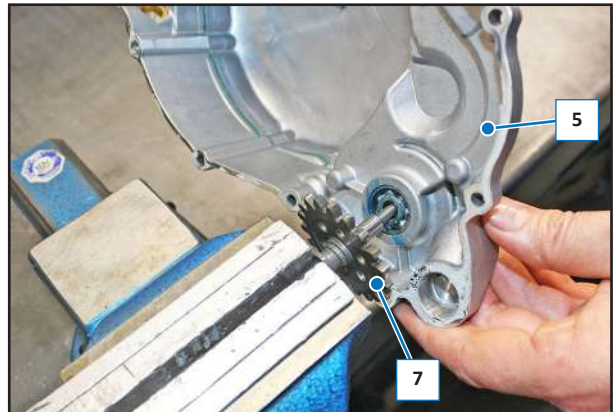

Check the condition of the seal (9) if damaged, replace.

Check the correct functioning of the bearing (10), if it does not slide freely replace; to replace, heat the crankcase to a temperature of 50° C and with a punch remove the bearing and reassemble the new one.

WARNING: Use suitable personal protection equipment;
Burns hazard.

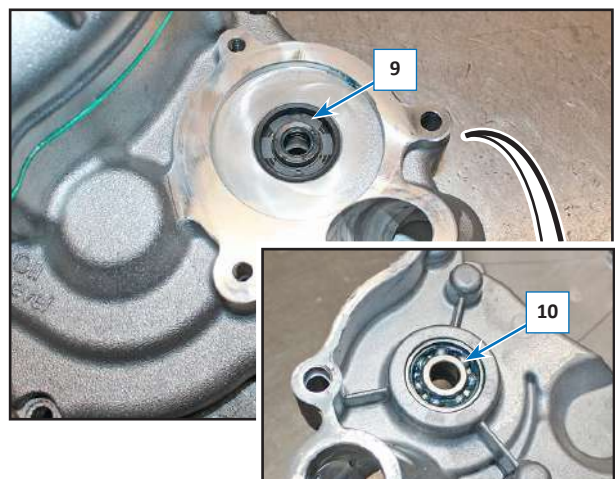

2.16.3 Reassembling the water pump

Grease the bearing (10) with graphite grease and lubricate the sealing gasket (9) with engine oil.

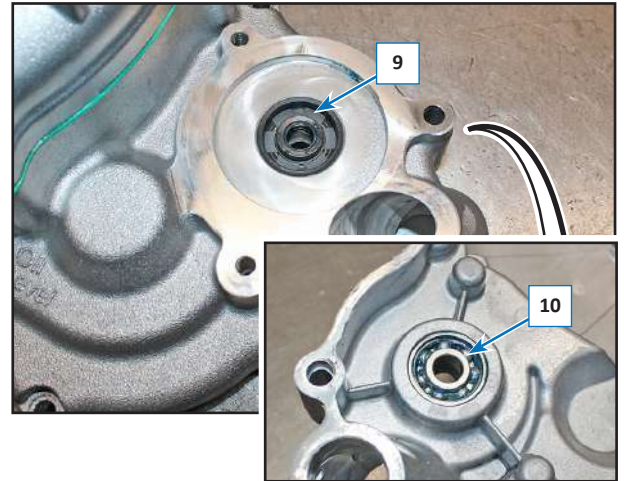

Insert the pump shaft (7) in the bearing (10) and in the seal (9).

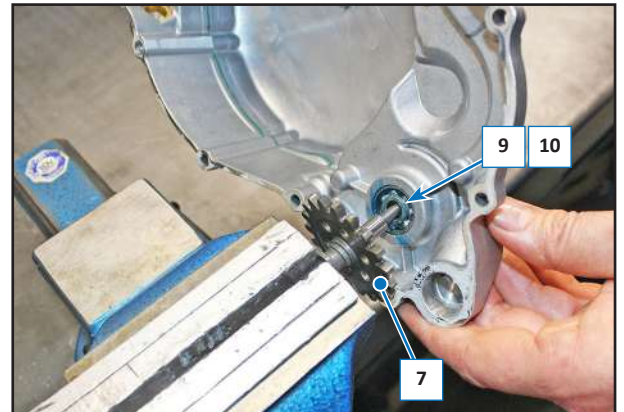

Place the shaft (7) in a vice and screw the impeller (8) with a torque of 6 Nm (0,6 kgm, 4,42 ft/lb), greasing the thread.

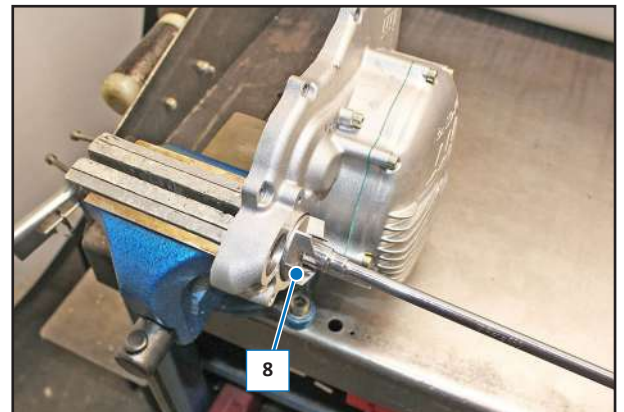

Refit the transmission cover as described in the relative paragraph.

Refit the pump cover (3) by tightening the screws (1) with a torque of 8Nm (0,8 kgm, 5,9 ft/lb) by replacing the aluminum washer (2) of the screw (1a).

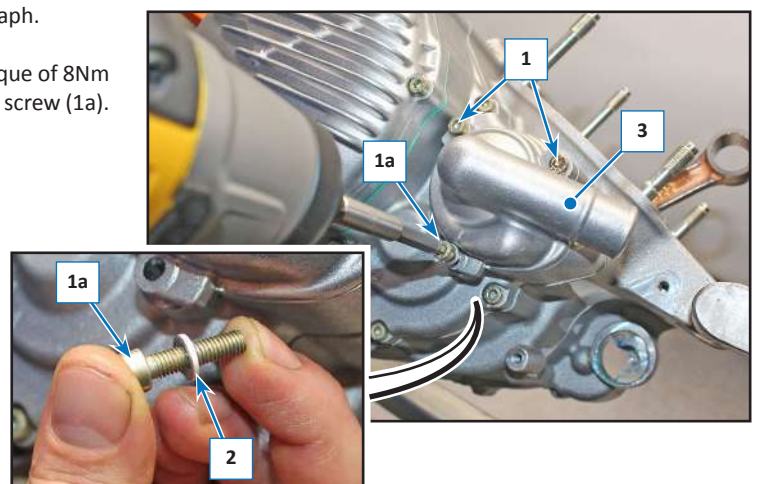

2.17 TRANSMISSION GUARD

Unscrew the screws (1):

- 1a) M5-L25 screw
- 1b) M5-L30 screw
- 1c) M5-L70 screw

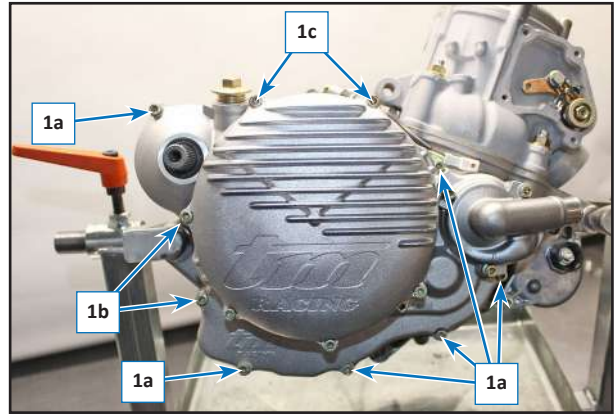

Remove the guard (2), with the aid of a rubber hammer.

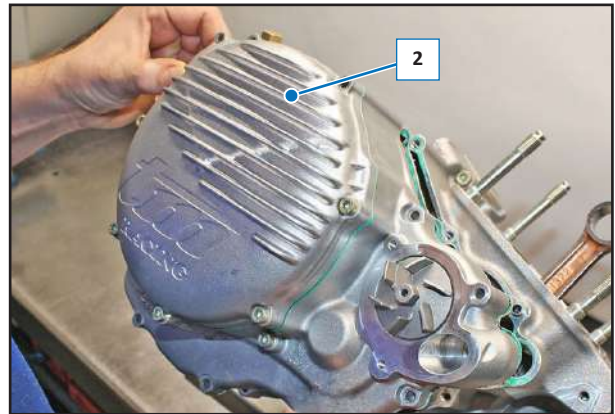

Remove the gasket (3).

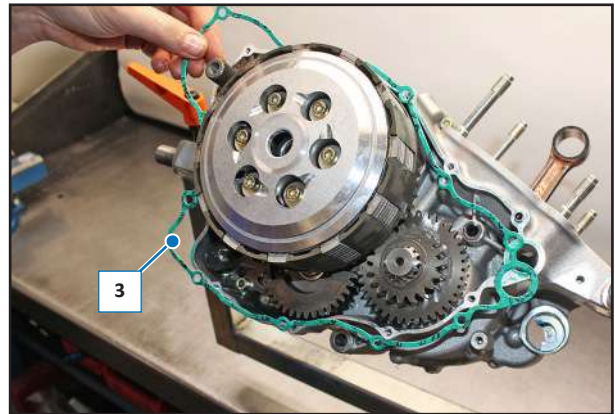

Recover the three centring bushes (4).



2.17.1 Transmission cover re-assembly

Clean the surface of the lid and the semicase from any residues.

Check that the three centring bushes (4) are in their respective housing.

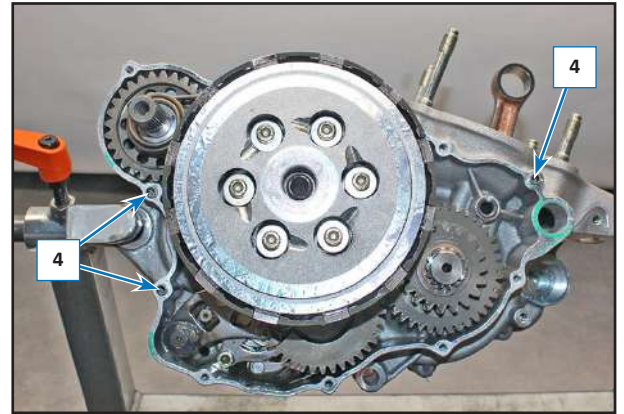

Replace and re-mount the gasket (3).

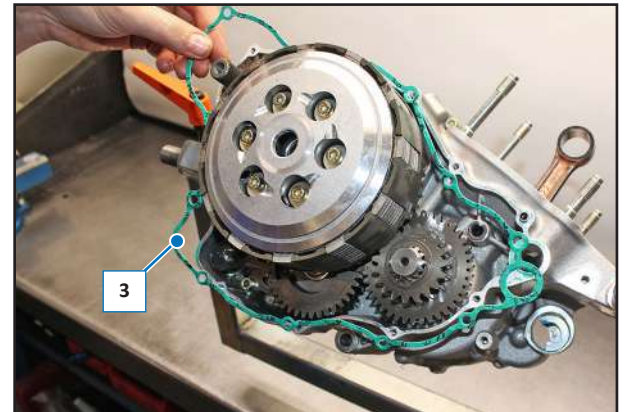

Mount the cover (2), centring it on the bushes (4), paying attention not to ruin the seals.

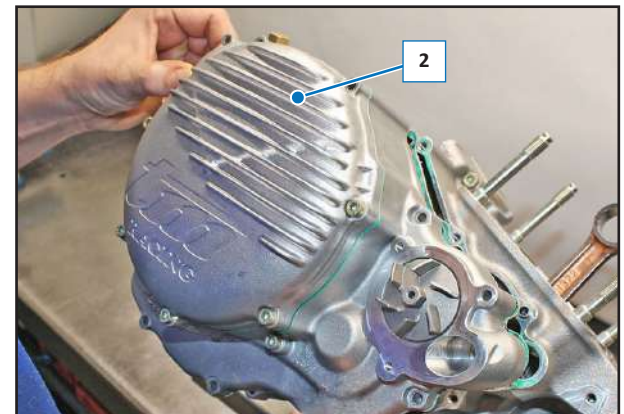

Tighten the screws (1) crosswise, positioning them in the relative housing, depending on their length.

- 1a) M5-L25 screw
- 1b) M5-L30 screw
- 1c) M5-L70 screw

First screw without tightening with a torque of 8 Nm (0.8 kgm/ 5.9 ft/lb).

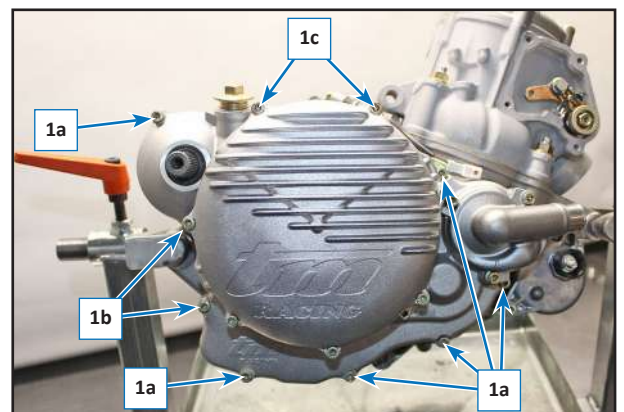

2.18 IDLE KICK STARTER REMOVAL (ONLY K.S.)

Remove the transmission cover and the clutch bell as described in the relative paragraphs.

Release the spring (1) from the relative housing, turn the starter (2) anti-clockwise by 1/4 of a turn.

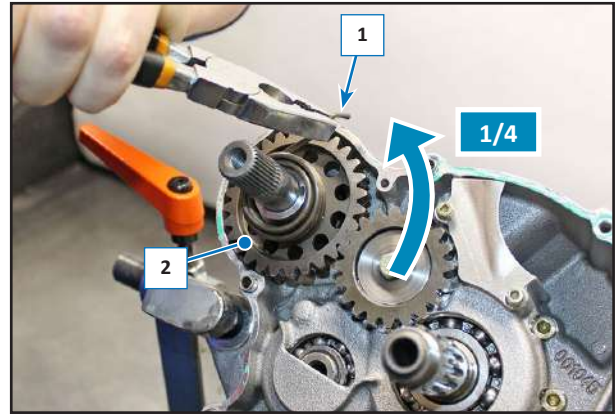

Remove the starter (2) complete with spring (3) and washer (4).

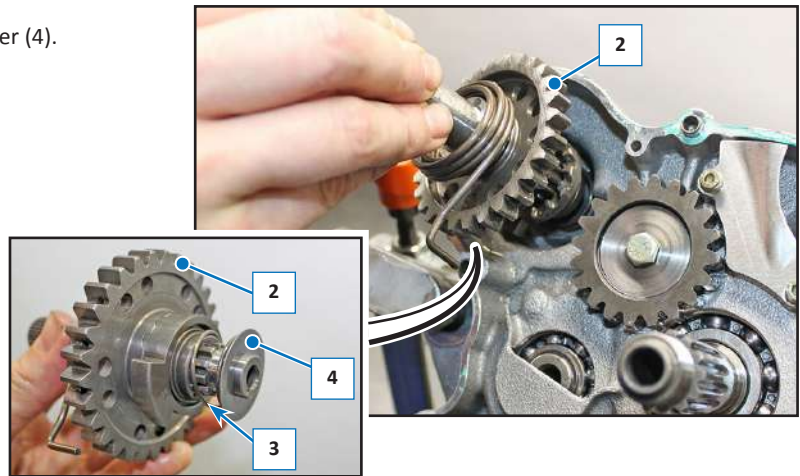

2.18.1 Starter dismantling

In sequence, remove the washer (4), spring (3), socket and ratchets (5), the seeger (6), shim (7), gear (8), shaft (9), socket (10) and the spring (1).

Re-assemble in reverse order to dismantling, paying attention to positioning the pin (11) of the spring (1) in the relative hole (12) on the shaft (9).

Time the ring nut (5) with the shaft (9) using the reference bolts (13).

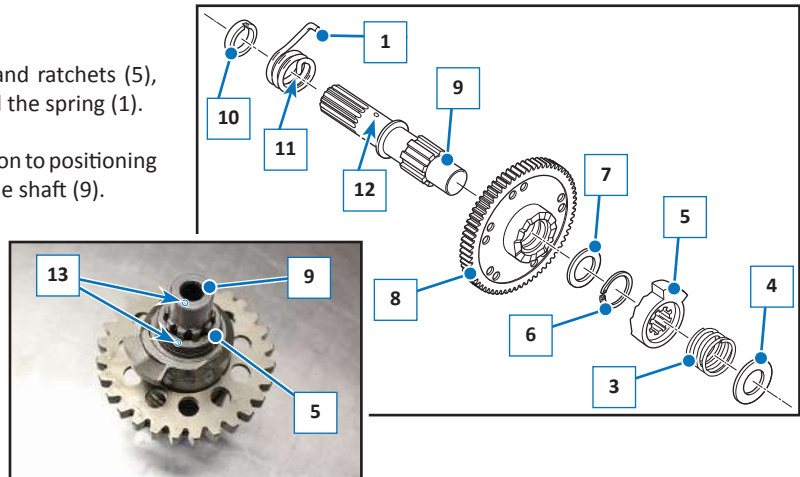

2.18.2 Re-mounting

Re-mount the idle kick start in the relative housing and then turn the starter (2) clockwise by 1/4 of a turn and insert the pin (1) in the hole in the guard.

NOTE: Lubricate the fitting hole abundantly with graphite grease.

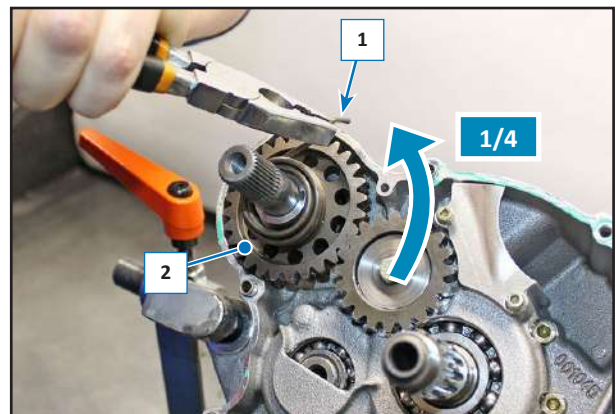

2.19 DRUM AND CLUTCH BELL

2.19.1 Disassembly

Remove the transmission cover as described in the relative paragraph.

Remove the clutch discs as described in the relative paragraph.

Open the lock washer (1) with a chisel.

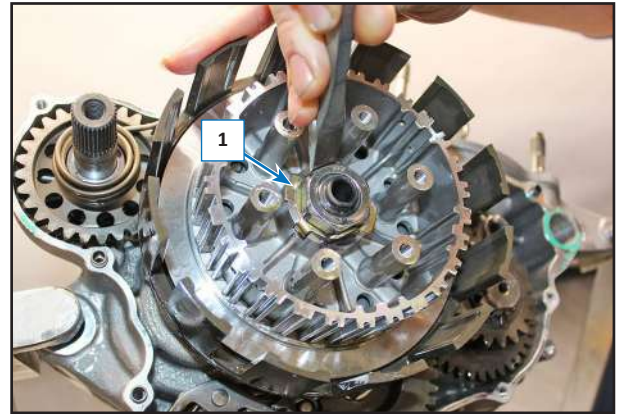

Use a spanner to block rotation of the clutch drum (2) and tighten the nut (3).

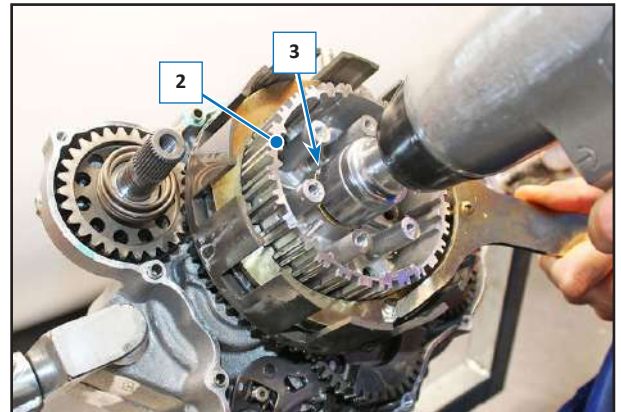

Remove the safety washer (1).

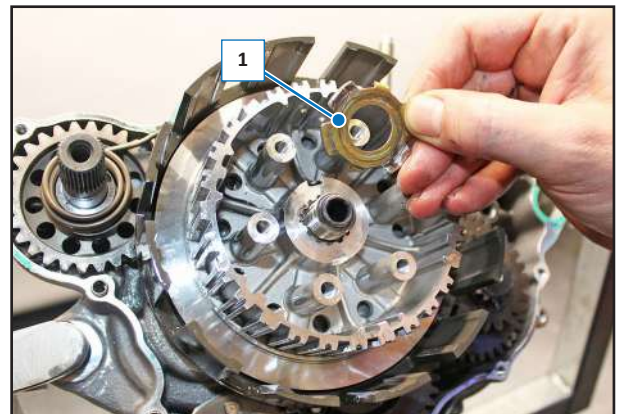

Remove the drum (2).

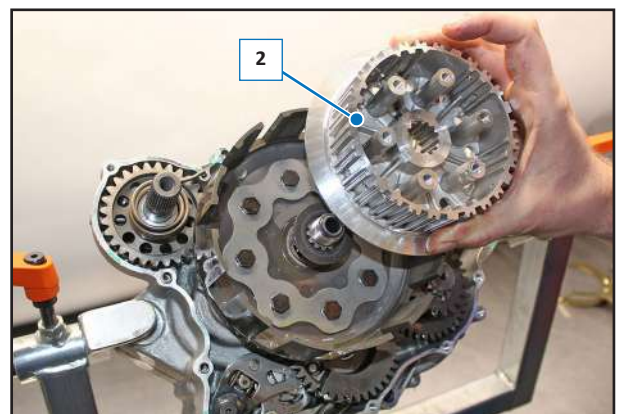

Remove the washer (4).

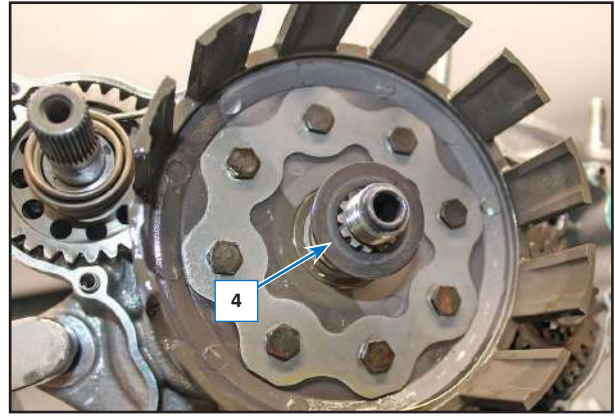

Remove the bell (5).

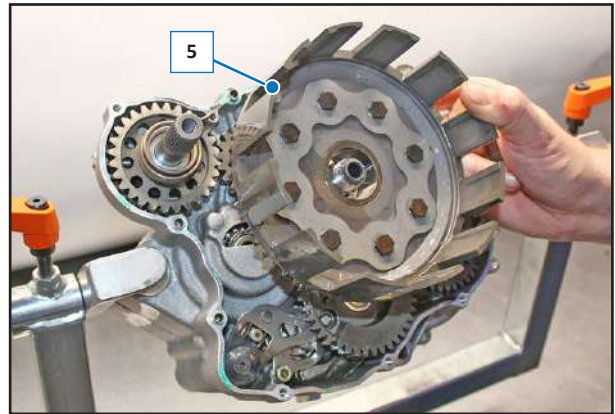

Remove the two roller bearing (6) and the spacer (7).

Remove the washer (8).

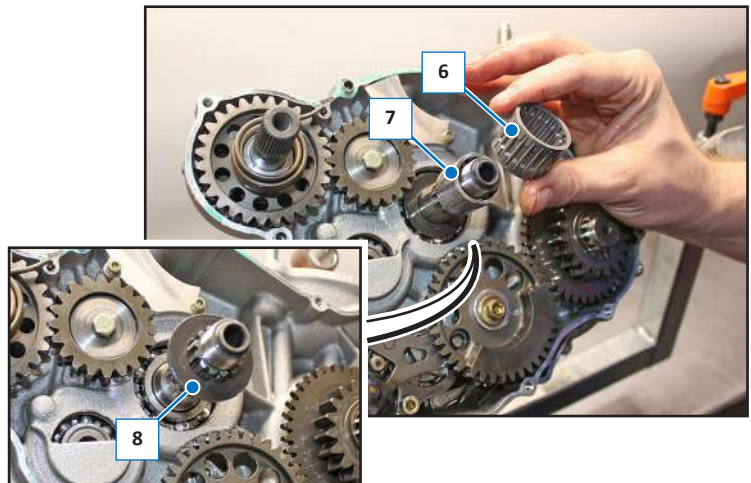

2.19.2 Re-mounting

Insert the washer (8).

Re-mount everything, proceeding in the reverse order to disassembly.

Make sure that the spacer (7) and ball bearing cage (6) are re-mounted correctly and lubricate them with engine oil.

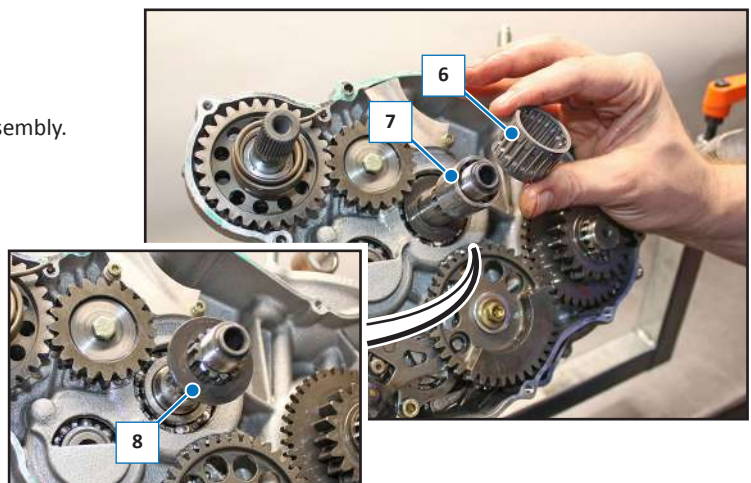

Re-mount the bell (5).

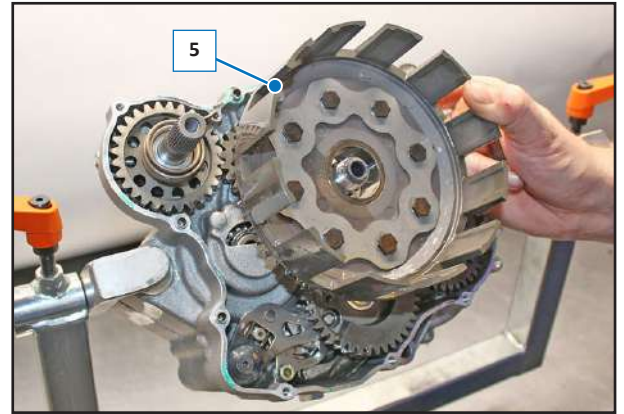

Insert the washer (4).

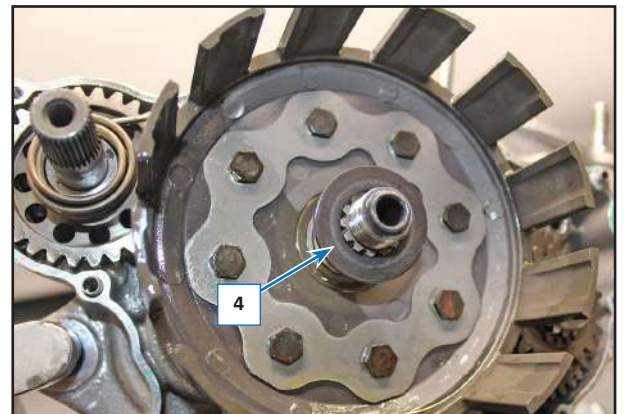

After having re-mounted the bell (5) and the drum (2), make sure the safety washer (1) has been positioned correctly.

Screw the nut (3), blocking drum rotation with a spanner, with torque of 100 Nm 10.0 kgm 73.75 ft/lb + strong threadlocker (green).

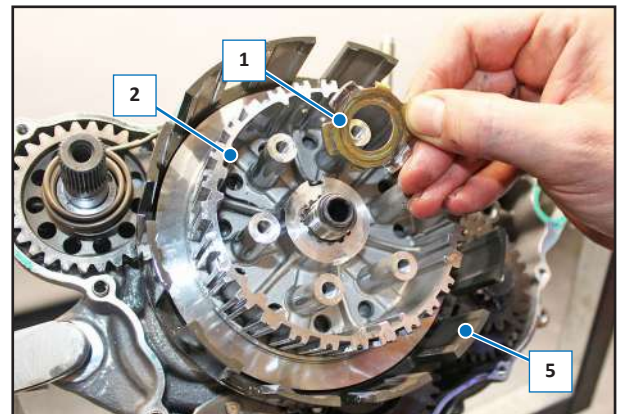

Lock the nut (3) by lifting the tabs of the lock washer (1).

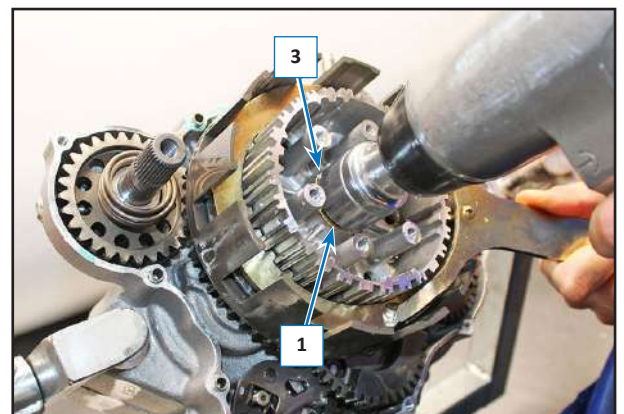

2.20 TRANSMISSION SIDE COUNTER GEARS

Components layout:

- 1) Countershaft gear
- 2) Idle gear kick starter removal
- 3) Kick starter
- 4) Gearbox primary shaft
- 5) Gearbox command shaft
- 6) Crankshaft gear

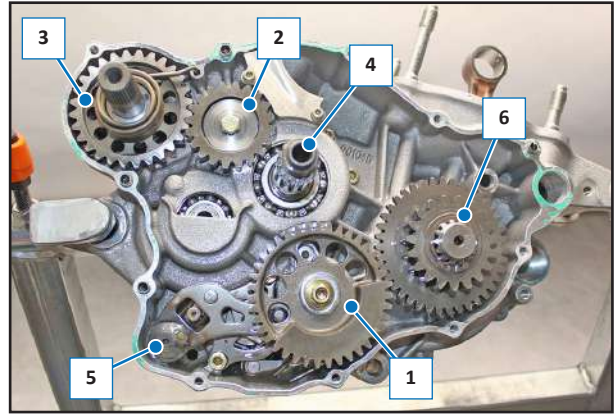

2.20.1 Gears removal

Remove the pedal start gear (3) as described in the relevant paragraph.

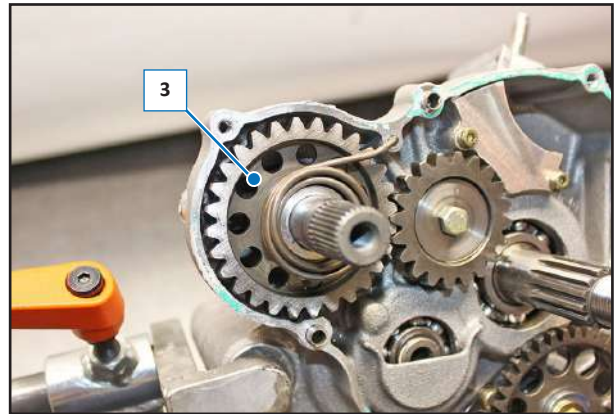

Unscrew the fixing screw (7) of the pedal start retaining gear (2).

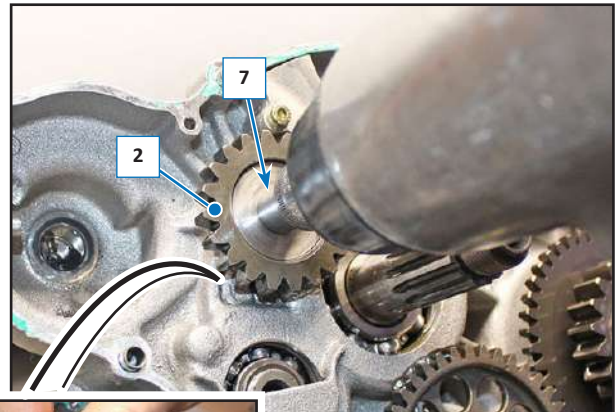

Remove the screw (7) and the washer (8).

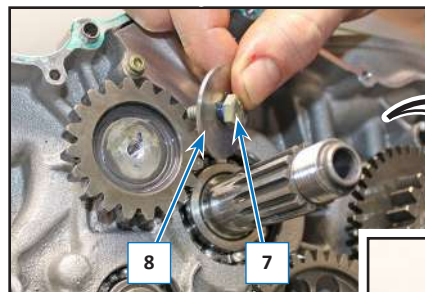

Remove the gear (2).

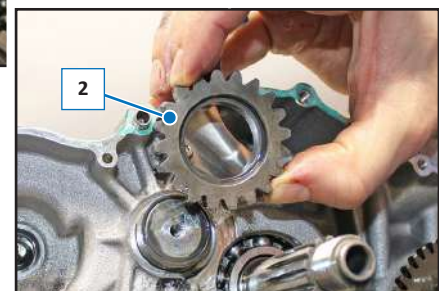

Unscrew the screw (9) of the countershaft (1).

Remove the gear (1).

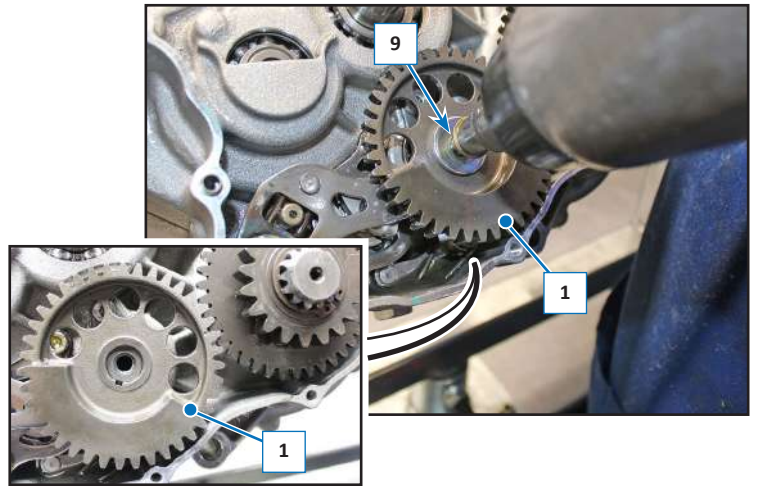

Collect the key (10).

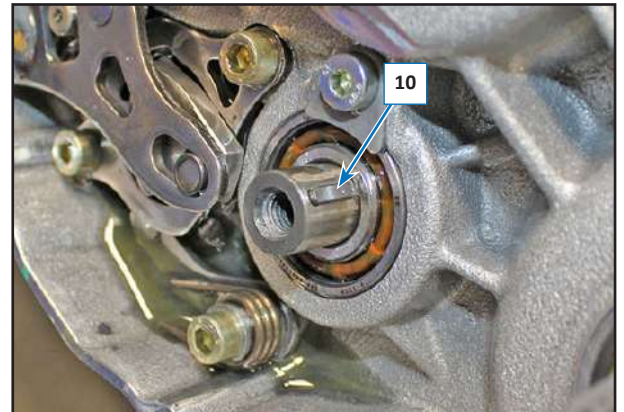

Remove the seeger (11) of the crankshaft gear (6).

Remove the crankshaft gear (6).

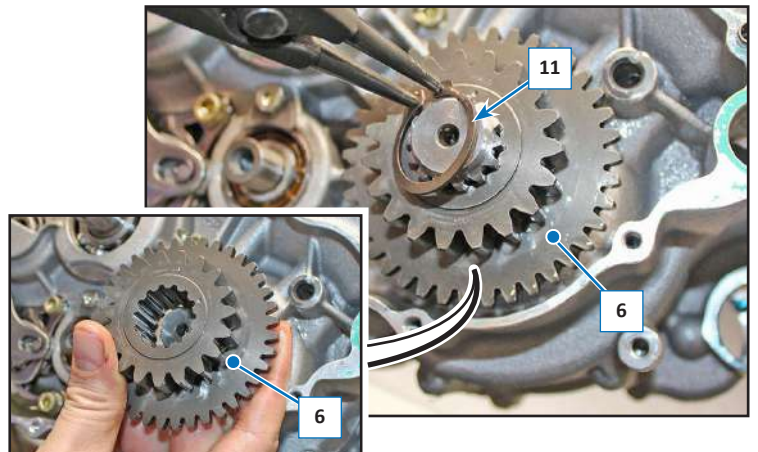

2.20.2 Reassembly of gears

Reassemble the gear (6) of the crankshaft by matching the arrow (12) stamped on the crankshaft with the reference dot (13) of the gear.

Reassemble the seeger (11).

Check that the key (10) is present.

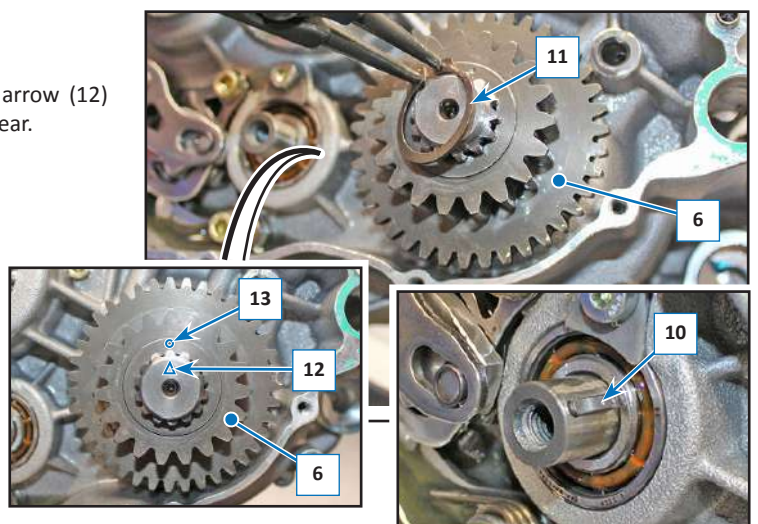

Reassemble the countershaft gear (1) by matching the timing point (14) of the countershaft gear with the timing point (15) of the crankshaft gear and put Loctite 243 on the oven (16) and not on the screw.

Tighten the screw (9) with a torque of 22 Nm (2,2 kgm, 16,22 ft/lb) + loctite 243.

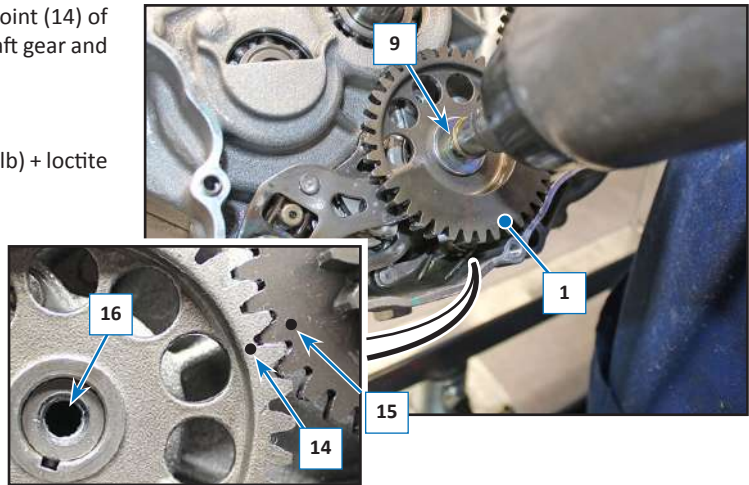

Put graphite grease on the bronze bush (17) and reassemble the gear (2).

Refit the washer (8) and the screw (7), put loctite 243 on the thread of the screw (7).

Tighten the screw (7) with a torque of 10 Nm (1 kgm, 7,37 ft/lb).

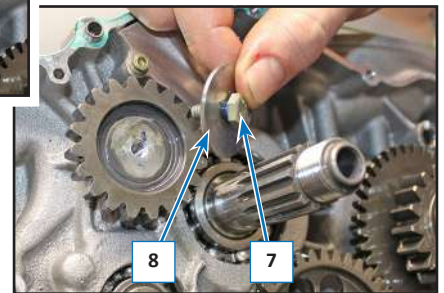
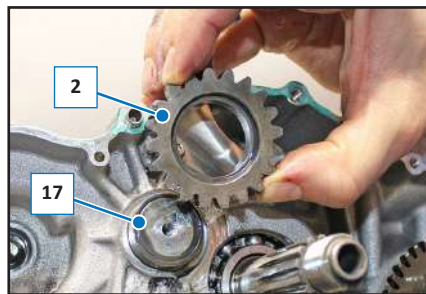
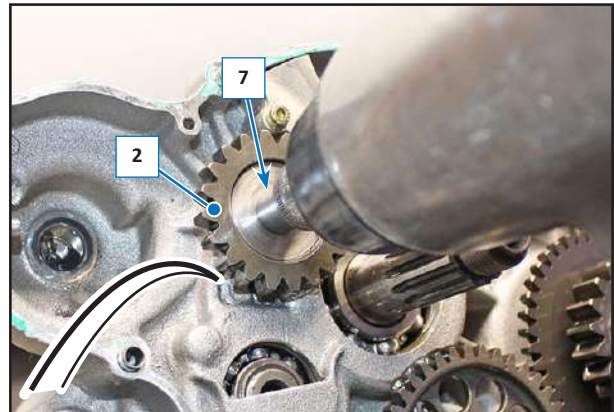

Reassemble the gear (3) of the pedal start as described in the relative paragraph.

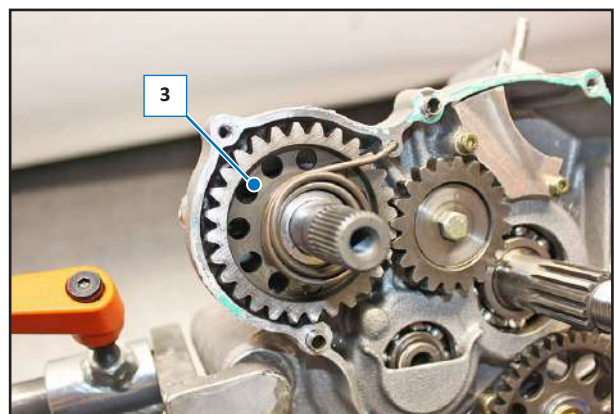

2.21 GEARBOX CONTROL SHAFT AND RATCHETS HOLDER REMOVAL

Disassembly

Turn the gearbox putting the 5th or 6th gear according to the type of engine.

Remove the transmission casing and the countershaft gear as described in the relevant paragraph.

Remove the gearbox control shaft (1) and recover the shim (2).

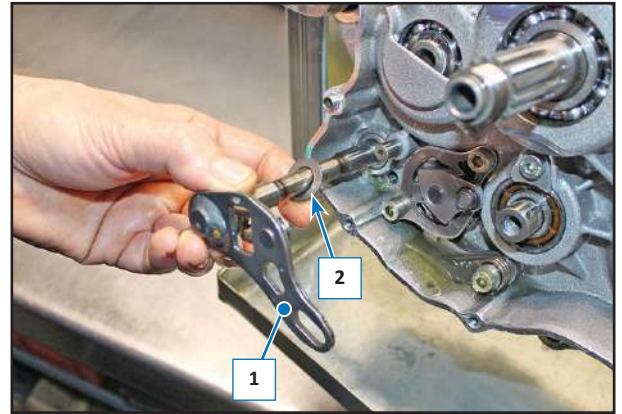

Remove the socket (3).

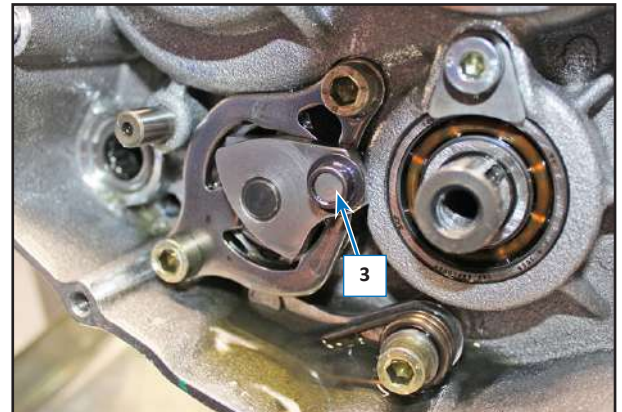

Unscrew the two screws (4).

Remove the pawl ratchet plate (5).

Remove the ratchet support (6) from the plate (5).

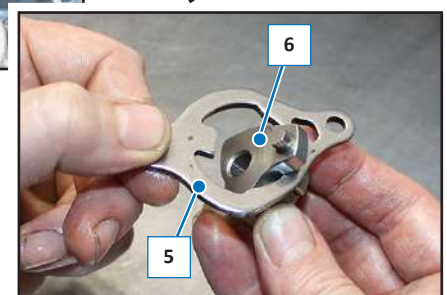
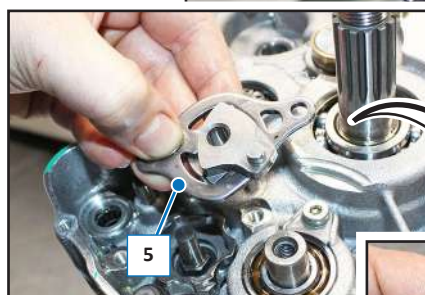
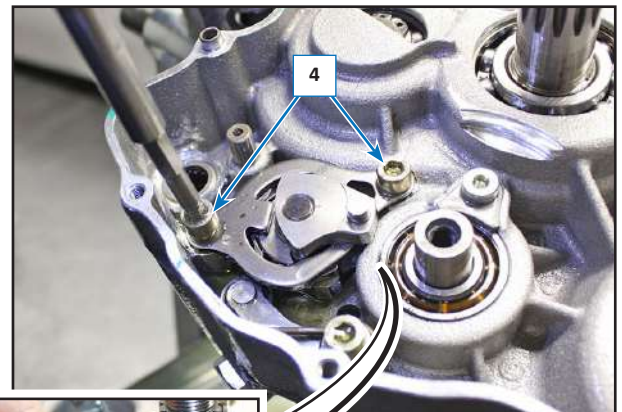

Dismantle the ratchets (7) and (8) with the relative tips (9) and the springs (10).

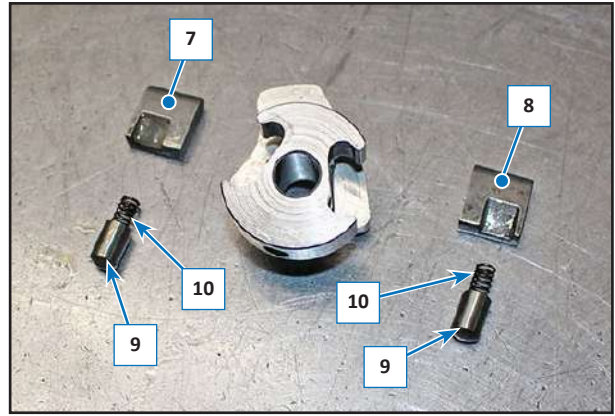

Unscrew the pin (11) securing the desmodromic shaft head (12).

Remove the pin (11).

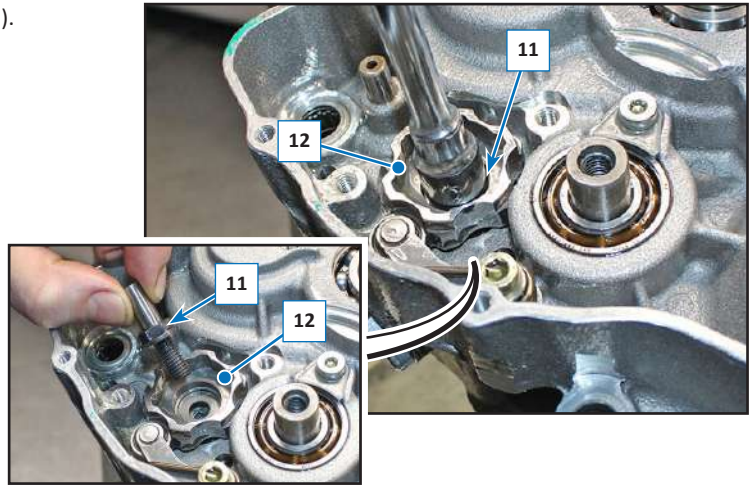

With a screwdriver (13) move the rod (14) and with a screwdriver (15) lever to remove the ring nut (12).

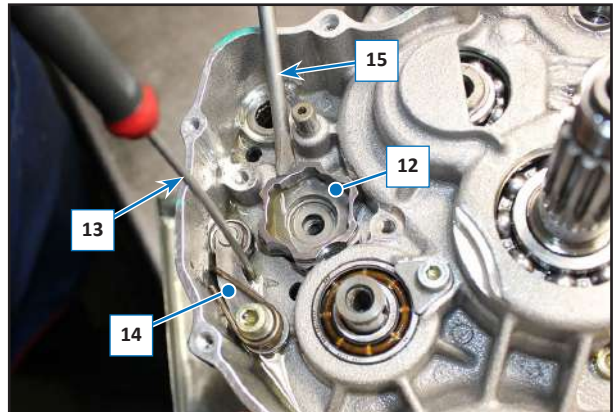

Remove the ring nut (12).

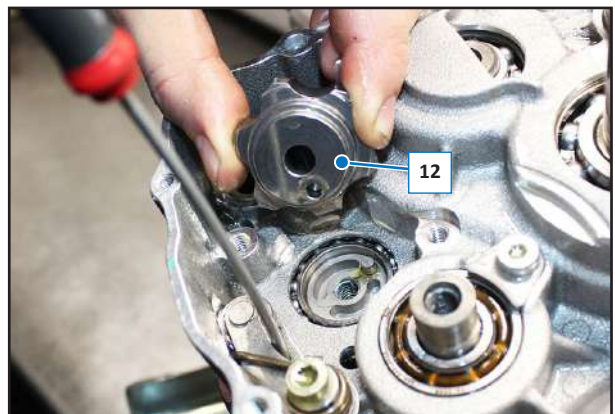

To remove the rod (14) unscrew the screw (16).

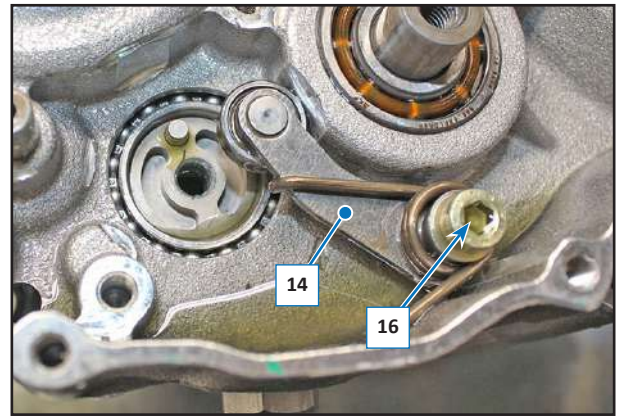

Reassembly

Reassemble the rod (14) by correctly positioning the spring (17) and tightening the screw (16) with a torque of 10 Nm (1 kgm, 7,37 ft/lb)

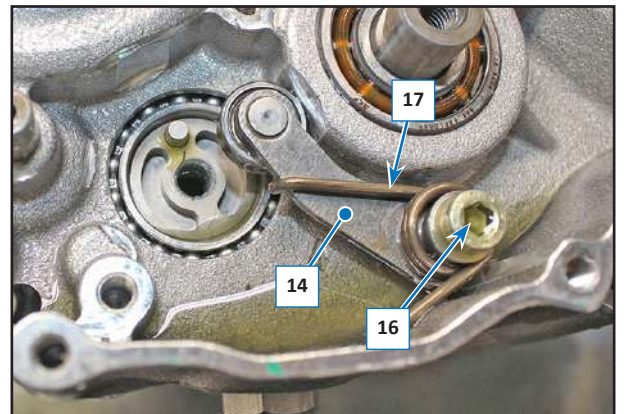

Use a screwdriver (13) to move the rod (14) and fit the gear selection ring (12) by inserting the hole (18) in the pin (19) of the drum (20).

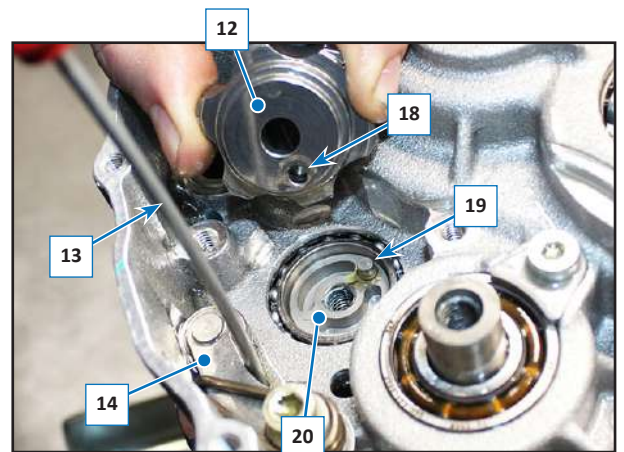

Screw the pin (11) with a torque of 10 Nm (1 kgm, 7,37 ft/lb) + Loctite 243.

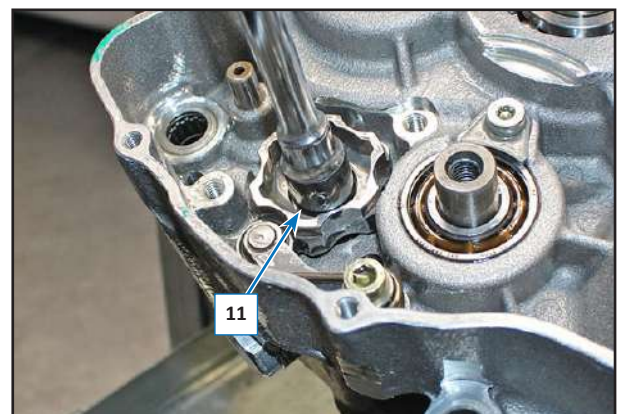

Reassemble the rod making sure that the ratchets (7) and (8) fit correctly into their seats; the two ratchets cannot be reversed.

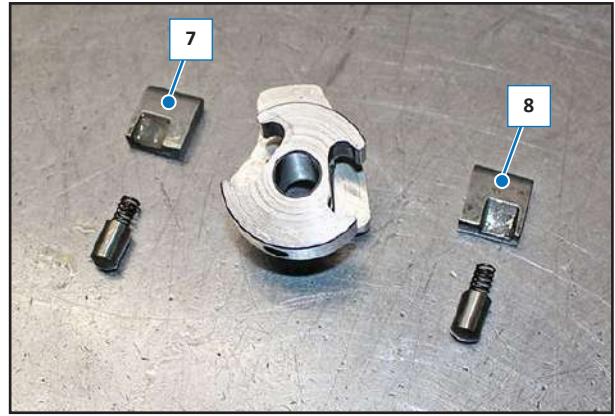

Fit the ratchet support (6) on the plate (5).

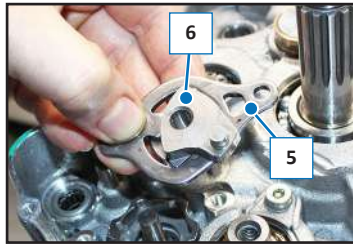

Fit the plate (5) on the pin (11) by inserting the ratchet support (6) in the ring nut (12), tighten the screws (4) with a torque of 10 Nm, (1 kgm, 7,37 ft/lb).

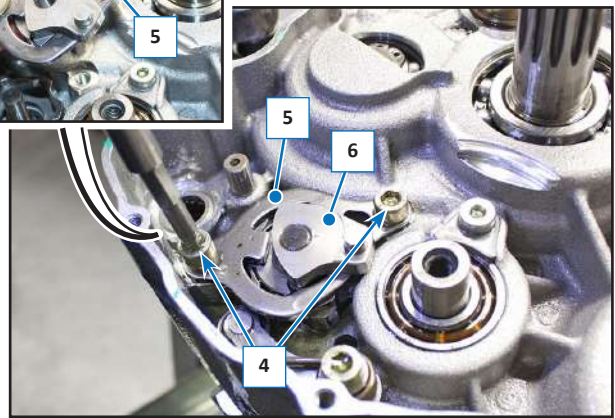

Mount the socket (3).

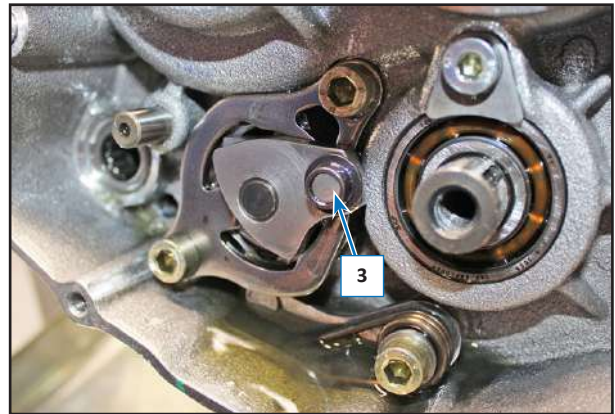

Insert the gearbox control shaft (1) with the shim (2).

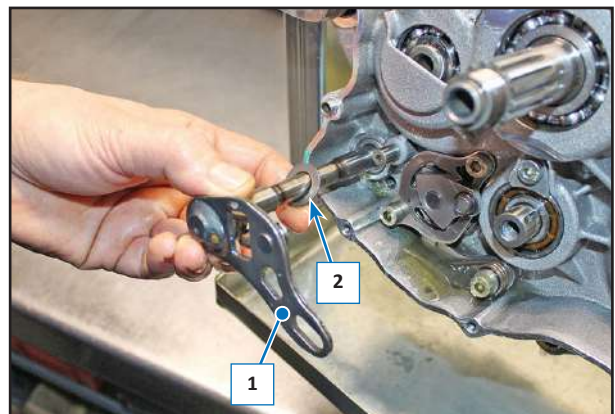

2.22 SEMICASE

Remove the heating unit as described in the relevant paragraph.

Remove all parts on the flywheel side and transmission side as described in the relative paragraphs.

2.22.1 Opening

On the transmission side, remove the gearbox secondary shaft locking seeger (1).

Unscrew the screws (2) **M6 x 50** and the screw (3) **M6 x 35**.

Turn the engine on the ignition side and remove the countershaft (4).

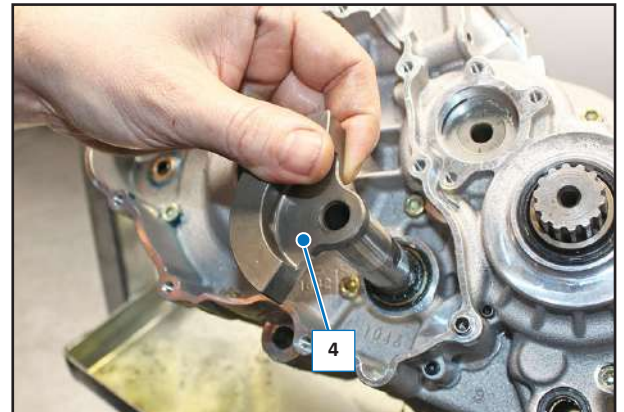
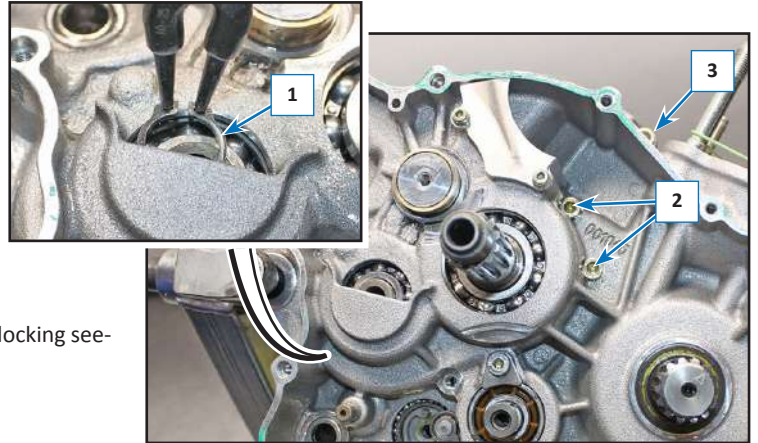

Undo the screws (5).

5a = **M6 x 50**

5b = **M6 x 35**

5c = **M6 x 60**

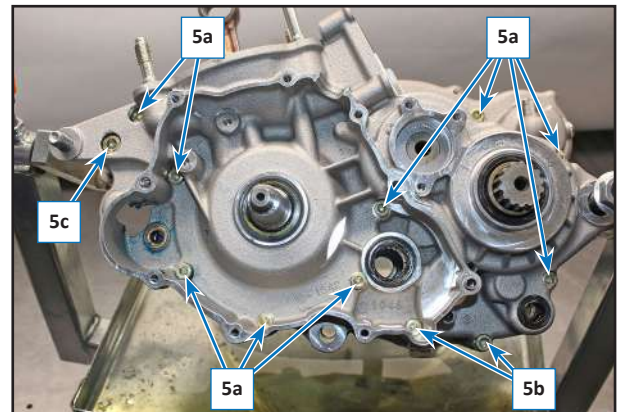

With a rubber hammer open the two split crankcases (6) and (7).

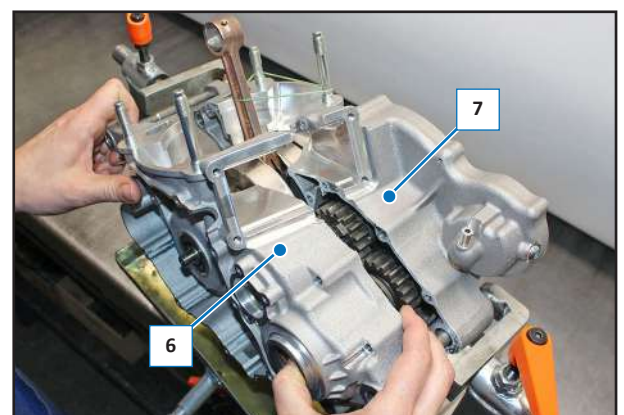

2.22.2 Re-assembly

Check that all components are correctly positioned in their housing and that the centring bushes (8) and (9) are mounted.

Clean, first with an iron spatula and then with scotch-brite, the contact surface from any residual sealant paste and then spread a Treebond type sealing paste.

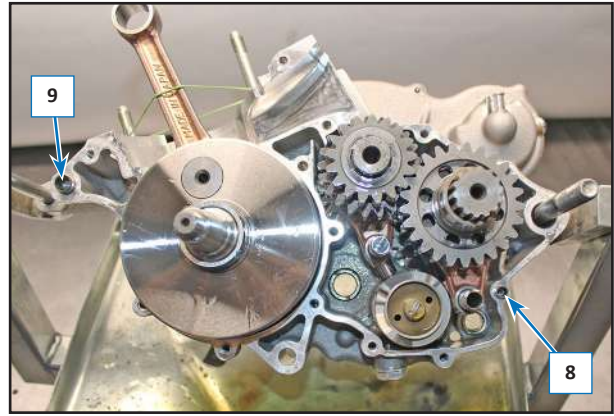

Couple the two split crankcases (6) and (7).

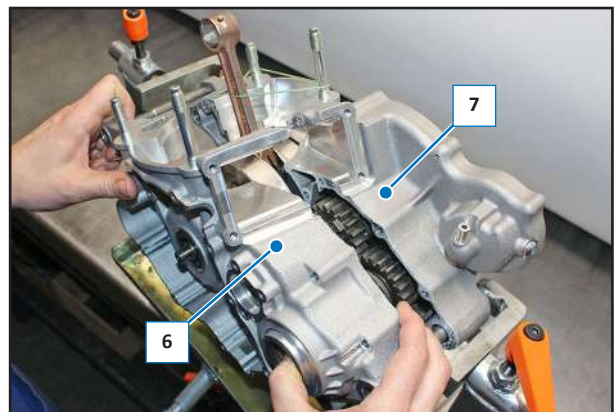

Re-position the screws (1) in the relative housing depending on their length and tighten them with torque of 12 Nm (1.2 kgm, 8.68 ft/lb):

- 5a = M6 x 50
- 5b = M6 x 35
- 5c = M6 x 60

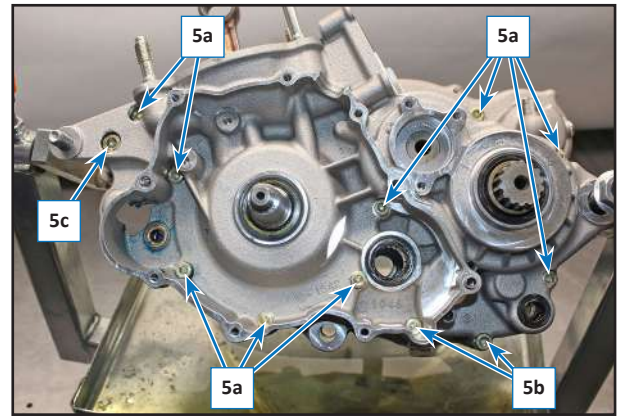

Refit the countershaft (4).

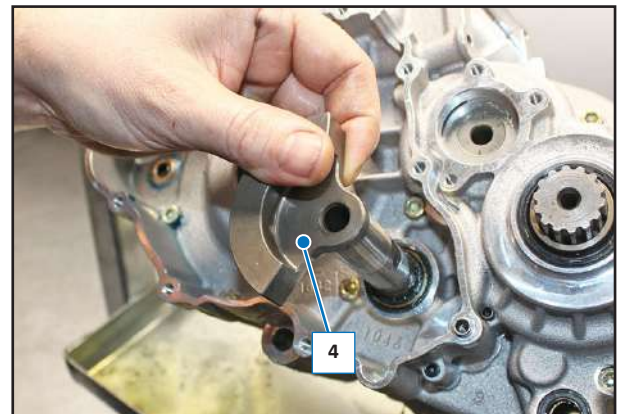

Tighten the screws (2) M6 x 50 and the screw (3) M6 x 35.

On the transmission side, replace the gearbox secondary shaft locking seeger (1).

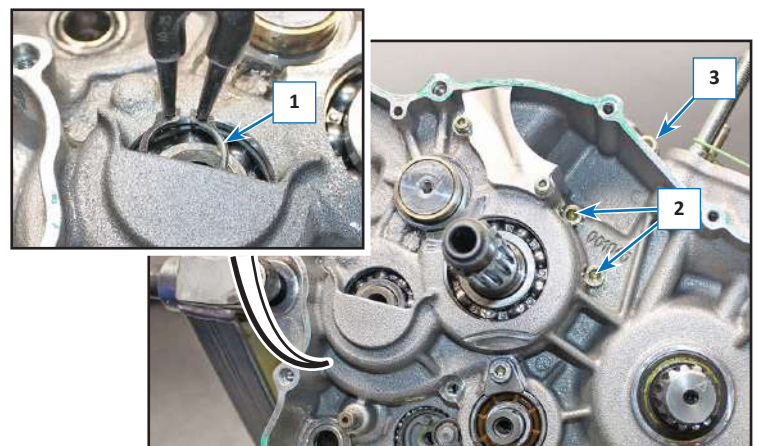

2.23 CRANKSHAFT, GEARBOX, GEARS DRUM

Open the guards as indicated in the relative section.

2.23.1 Components position

- 1) Crankshaft
- 2) Gearbox primary shaft
- 3) Gearbox secondary shaft
- 4) Gears selector drum (desmo)

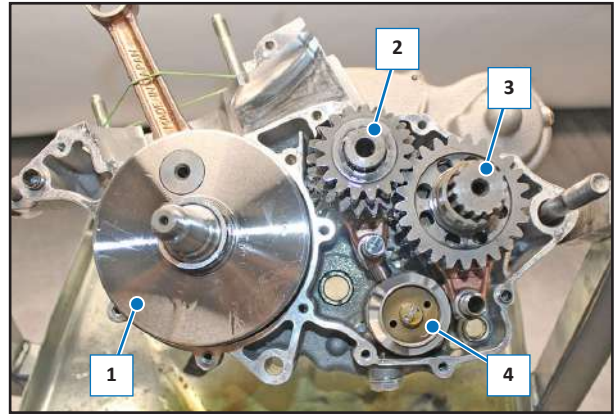

2.23.2 Crankshaft removal

Using a rubber hammer, slide the complete crankshaft (1) from the semicase. If necessary, heat the bearing to facilitate removal of the crankshaft.



2.23.3 Gear shafts removal

Extract the secondary shaft fork pin (1) complete with fork (2).

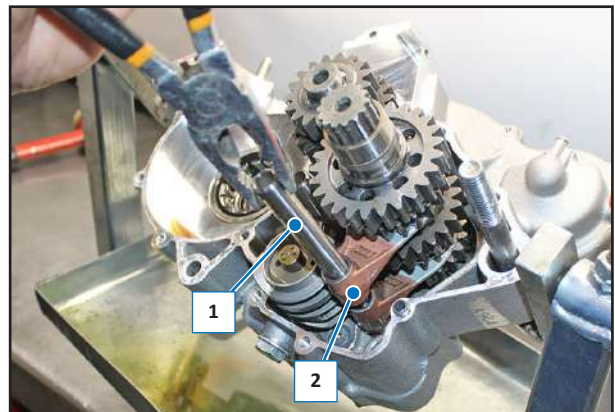

Slide the primary shaft fork pin (3) out.

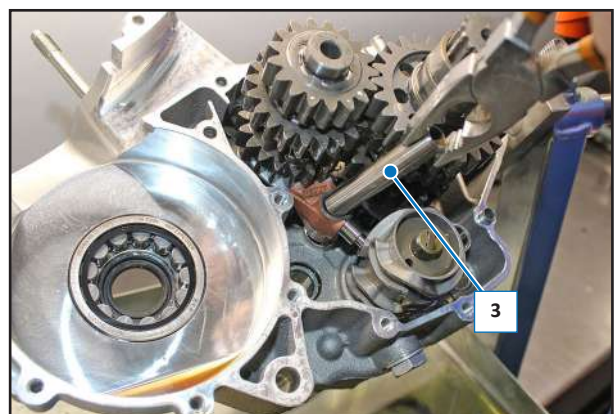

Spread the forks and remove the gear selector drum (4) (desmo).

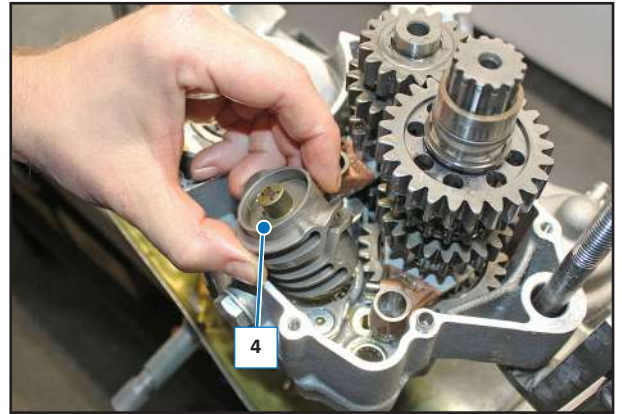

Remove the fork (5) of the primary shaft.

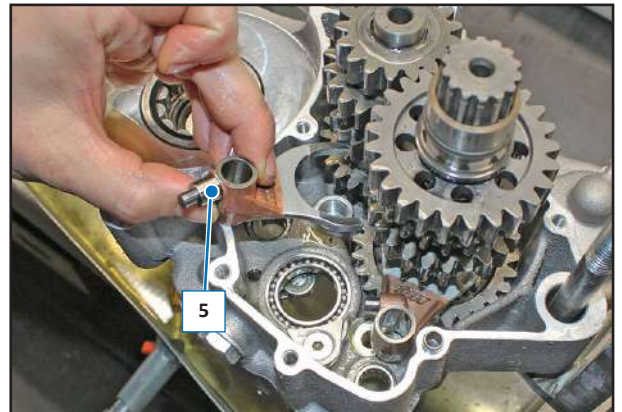

Remove the complete gear assembly (6) with the fork inserted.

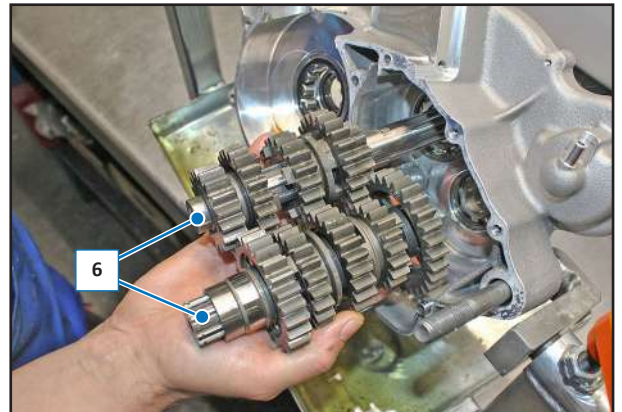

2.23.4 Primary shaft, gear sequence

- 2a) Primary shaft
- 2b) First
- 2c) Fifth
- 2d) Third
- 2e) Fourth
- 2f) Second

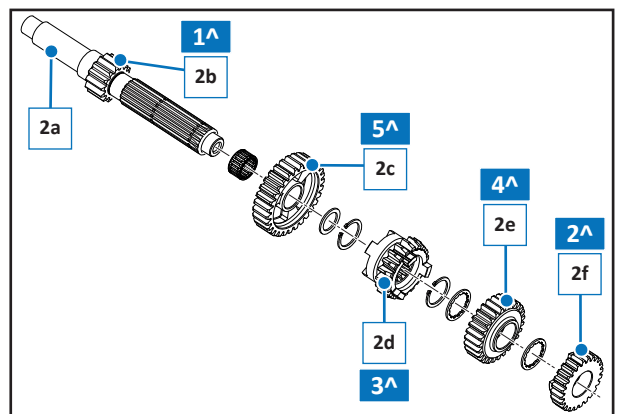

2.23.5 Secondary shaft, gear sequence

- 3a) Secondary shaft
- 3b) First
- 3c) Fifth
- 3d) Third
- 3e) Fourth
- 3f) Second

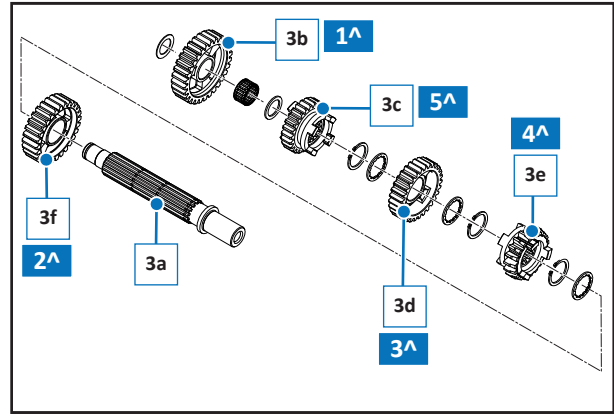

2.23.6 Bearings replacement

Unscrew the screws (1) that block the bearing and remove the plates (2).

Unscrew the screw (3) with relative bearing safety washer.

Remove all seals.

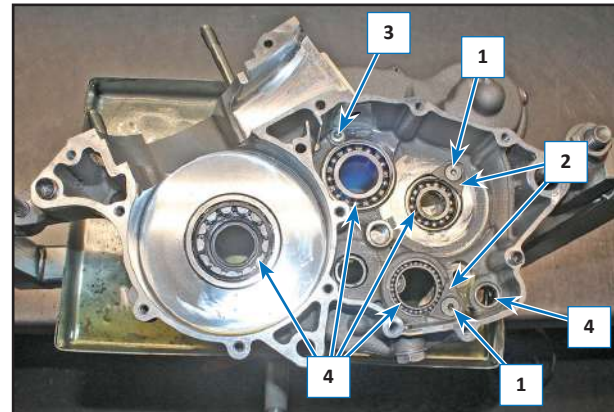

Heat the guards and remove the bearings (4).

NOTE: After having replaced the bearings, re-position the safety washers and tighten the screws again and applying Loxeal 82-33 on the thread.

Replace the seals and reassemble them in their relative positions paying attention to the insertion side.

Spread graphite grease on the seals.

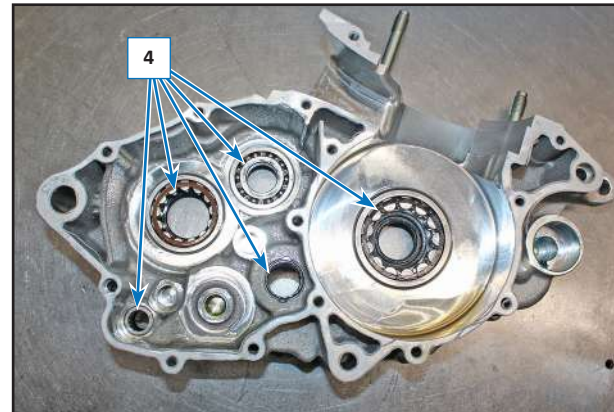

2.23.7 Components re-mounting

Check the condition of the OR gasket (9); if damaged, replace.

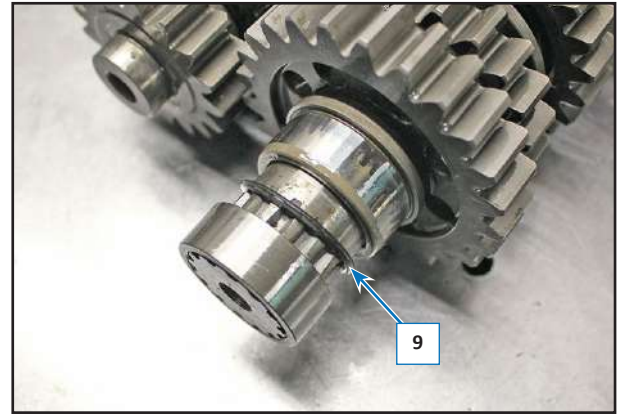

NOTE: Check that the pin (8) of the fork (2) is not worn, if worn replace.

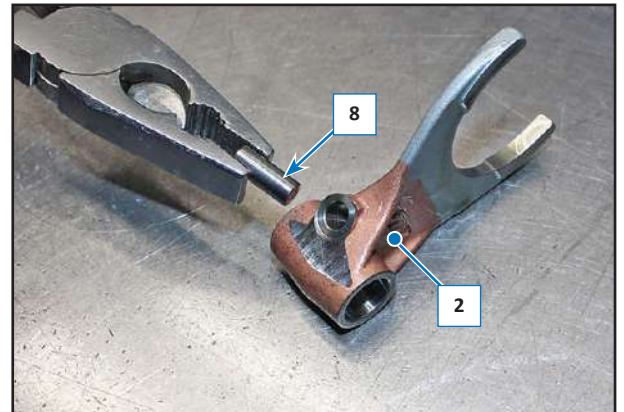

Check that the fork rollers are correctly inserted in the relative hollows on the drum (6).

NOTE: The forks are different from each other, do not reverse.

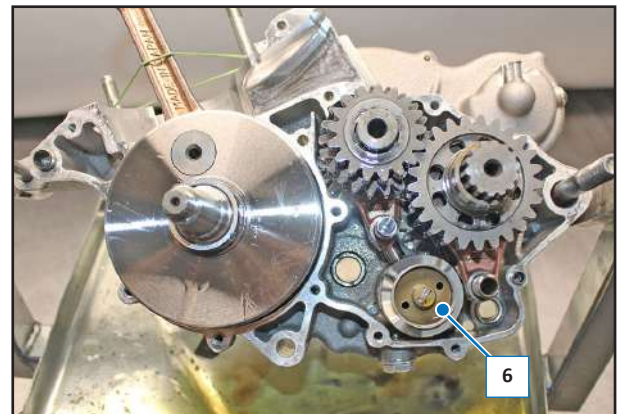

Re-mount the components, proceeding in reverse order to disassembly, lubricating with engine oil and, when re-mounting the gearbox unit, paying attention to correctly position the forks (2, 5 and 7) in the relevant positions:

Fork (2) cod.33024 between the 5th and 3rd gear.

Fork (7) cod.33023 between the 4th and 6th gear.

Fork (5) cod.33018 between the 3rd and 4th gear.

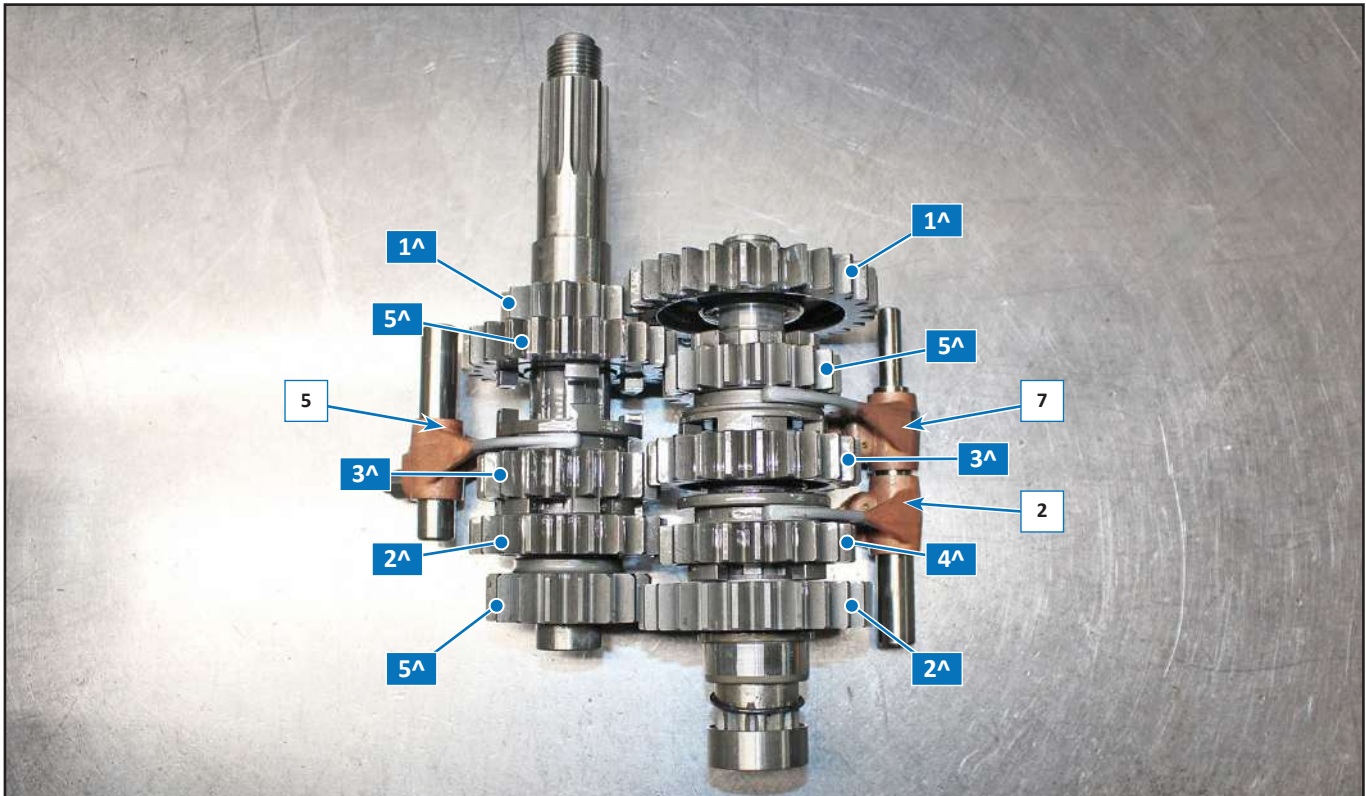

tm
RACING

tm
RACING

